

# Instruction Manual

## Turbo Instrument Controller (TIC)



dcsl/6399/001

Description	Item Number
TIC Turbo & Instrument Controller 100 W	D39721000
TIC Turbo & Instrument Controller 200 W	D39722000

Original Instructions



## Copyright notice

©Edwards Limited 2023. All rights reserved.

## Trademark credits

Edwards and the Edwards logo are trademarks of Edwards Limited, Innovation Drive, Burgess Hill, West Sussex RH15 9TW.

## Disclaimer

The content of this manual may change from time to time without notice. We accept no liability for any errors that may appear in this manual nor do we make any expressed or implied warranties regarding the content. As far as practical we have ensured that the products have been de-signed and constructed to be safe and without risks when properly installed and used in accordance with their operating instructions.

We accept no liability for loss of profit, loss of market or any other indirect or consequential loss whatsoever.

Product warranty and limit of liability are dealt with in our standard terms and conditions of sale or negotiated contract under which this document is supplied.

You must use this product as described in this manual. Read the manual before you install, operate, or maintain the product.W.

# Contents

Section	Page
<b>1</b>	<b>Introduction ..... 1</b>
1.1	Scope and definitions ..... 1
1.2	Product description ..... 1
<b>2</b>	<b>Technical data ..... 3</b>
2.1	Electrical data ..... 3
2.2	Operating and storage data ..... 3
2.3	Mechanical data ..... 3
2.4	Connections ..... 4
2.4.1	Active gauge connectors ..... 4
2.4.2	Turbo pump connector ..... 5
2.4.3	Backing pump connector ..... 6
2.4.4	Auxiliary terminals ..... 7
2.4.5	Logic interface ..... 8
2.4.6	Serial communications ..... 9
<b>3</b>	<b>Installation ..... 11</b>
3.1	Unpack and inspect ..... 11
3.2	Fitting the controller ..... 11
3.3	Controller electrical connections ..... 14
3.3.1	Connecting the electrical supply ..... 15
3.3.2	Additional earth bonding ..... 15
3.3.3	Connecting an active gauge ..... 16
3.3.4	Connecting a turbo pump ..... 16
3.3.5	Connecting a backing pump ..... 16
3.3.6	Connecting a vent valve ..... 16
3.3.7	Connecting an air cooler ..... 16
3.3.8	Connecting the logic interface ..... 17
3.3.9	Connecting the serial interface ..... 19
<b>4</b>	<b>Operation ..... 21</b>
4.1	Front panel description ..... 21
4.2	Menu structure ..... 22
4.3	Navigating the menu ..... 24
4.4	The view screen ..... 24
4.5	Turning gauges, pumps and relays on/off ..... 25
4.6	Changing list items ..... 25
4.7	Changing numerical values ..... 26
4.7.1	Entering negative components e.g. 5.00E-03 ..... 26
4.8	Turbo setup ..... 27
4.8.1	Introduction ..... 27
4.8.2	Default turbo setup options ..... 27
4.8.3	Additional setup options using a DX or nEXT pump ..... 28
4.9	Backing setup ..... 30
4.10	Gauge setup ..... 31
4.10.1	Default setup options (all gauges) ..... 31
4.10.2	Gauge status messages ..... 32
4.10.3	Active Pirani Gauge (APG) ..... 32
4.10.4	Active Strain Gauge (ASG2) control ..... 34
4.10.5	Active Inverted Magnetron (AIM) Gauge control ..... 35
4.10.6	Active Ion Gauge (AIGX-S) control ..... 36

4.10.7	Wide Range Gauge (WRG) .....	37
4.10.8	Wide Range Hot Cathode Gauge (WRH) .....	38
4.11	Alarms .....	39
4.12	The main menu .....	39
4.13	Turbo status .....	39
4.14	Backing status .....	40
4.15	Linking gauges and pumps .....	41
4.16	Parameters/units .....	42
4.17	Screen options .....	43
4.17.1	Organising gauges on the view screen .....	43
4.18	Relay setpoint outputs .....	44
4.19	Service information .....	44
4.20	Electrical supply failure .....	44
<b>5</b>	<b>Maintenance .....</b>	<b>47</b>
5.1	Safety .....	47
5.2	Fault finding .....	47
5.3	Cleaning the controller .....	48
5.4	Software updates .....	48
5.5	Factory defaults .....	49
<b>6</b>	<b>Storage and disposal .....</b>	<b>51</b>
6.1	Storage .....	51
6.2	Disposal .....	51
<b>7</b>	<b>Service, spares and accessories .....</b>	<b>53</b>
7.1	Introduction .....	53
7.2	Service .....	53
7.2.1	Return the equipment or components for service .....	53
7.3	Spares .....	54
7.4	Accessories .....	54

# Illustrations

Figure		Page
1	Pin connections for an 8-way FCC/RJ45 .....	4
2	Pin connections for a 15-way sub-miniature 'D' type socket .....	5
3	Pin connections for a 15-way sub-miniature 'D' type socket .....	6
4	4-way screw terminal block .....	7
5	Pin connections for a 25-way sub-miniature 'D' type socket .....	8
6	Pin connections for a 9-way sub-miniature 'D' type socket .....	9
7	Dimensions of a bench mounted TIC (mm) .....	12
8	Front panel removal .....	13
9	Rack mounting of a TIC .....	13
10	Panel cutout drawing .....	14
11	Rear panel connections .....	15
12	IBM PC RS232 interface - 9-way .....	19
13	IBM PC RS232 interface - 25-way .....	19
14	RS485 TIC network .....	20
15	Front panel display .....	21
16	View screen shortcuts .....	22
17	Menu structure .....	23
18	View screen .....	24
19	Gauge output displayed .....	25
20	Changing numerical values .....	26
21	Turbo setup screen .....	27
22	Gauge setup screen .....	31
23	Gauge setup screen APGX-M .....	33
24	Gauge setup screen ASG2 .....	34
25	Gauge setup screen AIGX .....	36
26	Gauge setup screen WRG .....	38
27	Controlled item .....	42
28	Control setup .....	42
29	Gauge order setup .....	43

## Tables

Table	Page
1 Compatible equipment for the TIC range .....	2
2 Gauge connector pin-out .....	4
3 Turbo pump connector pin-out .....	5
4 Backing pump connector pin-out .....	7
5 Auxiliary connector pin-out .....	8
6 Logic interface connector pin-out .....	8
7 Serial communications connector pin-out .....	10
8 Checklist of components .....	11
9 Front panel symbols and their functions .....	21
10 Default turbo setup options .....	27
11 Error/diagnostic monitoring, turbos .....	28
12 Turbo pump vent setup differences .....	29
13 Turbo pump vent options .....	29
14 Turbo pump vent type .....	29
15 DX and nEXT pump setup options .....	29
16 Error/diagnostic monitoring, DX, nEXT and nXDS pumps .....	30
17 Default Backing setup options .....	30
18 nXDS pump setup options .....	31
19 Default setup options (all gauges) .....	31
20 Gauge status messages .....	32
21 Display range .....	32
22 Error/diagnostic monitoring APG .....	33
23 Setup options Linear APG gauges .....	33
24 Error/diagnostic monitoring APGX .....	33
25 Setup options ASG2 .....	34
26 Error diagnostic monitoring ASG2 .....	35
27 Error/diagnostic monitoring AIM .....	35
28 Setup options AIGX .....	36
29 Error/diagnostic monitoring AIGX .....	37
30 Setup options WRG .....	37
31 Error/diagnostic monitoring WRG .....	38
32 Setup options WRH .....	39
33 Error monitoring .....	39
34 nEXT Service Screen .....	40
35 nEXT Service Reset Screen .....	40
36 nXDS Service Screen .....	41
37 nXDS Service Reset Screen .....	41
38 Fault finding .....	47
39 Factory default settings .....	49
40 Spares .....	54
41 Accessories .....	54

# 1 Introduction

## 1.1 Scope and definitions

This manual provides installation, operation and maintenance instructions for Edwards Turbo Instrument Controller (TIC). The Turbo Instrument Controller must be used as specified in this manual. Read this manual before installing and operating the Turbo Instrument Controller.

Important safety information is highlighted as WARNING and CAUTION instructions; these instructions must be obeyed. The use of WARNINGS and CAUTIONS is defined below.



### WARNING

Warnings are given where failure to observe the instruction could result in injury or death to people.

### CAUTION

Cautions are given where failure to observe the instruction could result in damage to the equipment, associated equipment and process.

The units used throughout this manual conform to the SI international system of units of measurement.

The following warning labels are on the controller:



Warning - refer to accompanying documentation.



Edwards offers European customers a recycling service.

## 1.2 Product description



### WARNING

Improper use of the equipment could cause damage to it or injury to people. The responsibility for the safe operation and maintenance of the equipment is with the user. Hazardous voltages should not be connected to this unit except where specified.

There are two variants of the combined Turbo and Instrument Controller, both of which are provided with a large, clear graphics display, easy-to-use control interface via a touch sensitive keypad, an RS232/485 interface for control and data monitoring on a remote PC and a logic interface for interface with associated system hardware.

The compatible instruments/pumps that can be used with the combined TIC are listed in [Table 1](#).

Table 1 - Compatible equipment for the TIC range

TIC variant	Compatibility
TIC Turbo and Instrument Controller 100 W	Up to 3 active gauges including: APG series gauge, ASG2, AIM, WRG and AIGX nEXT240/300/400 family - slow ramp nEXT85 family - fast ramp nEXT 730/930/1230 - Control only Mains backing pumps, XDS scroll, up to RV12 (via an optional relay box) Air Cooler, ACX70 and ACX250 Vent Valve, TAV5 and TAV6 Bakeout band (via an optional relay box) 24 V backing line valves, LCPV16EKA and LCPV25EKA (via an optional relay box)
TIC Turbo and Instrument Controller 200 W	Same as the 100 W version plus the following: 24 V backing pump nEXT 85/240/300/400 - fast ramp nEXT 730/930/1230 - Control only nXDS, nXRi - Control only
Legacy connectable product	EXT75DX - fast ramp EXT255DX - slow ramp EXT70H + EXDC80 - fast ramp EXT255H + EXDC80 - slow ramp EXT255H + EXDC160 - fast ramp EXT255DX - fast ramp



## 2 Technical data

### 2.1 Electrical data

Connector type	CEE/IEC 320
Electrical supply	100 - 240 V a.c. 50/60 Hz
Power consumption	
TIC Turbo and Instrument Controller 100 W	215 VA maximum (D39721000)
TIC Turbo and Instrument Controller 200 W	350 VA maximum (D39722000)
Peak inrush current	11 A at 110 V a.c. } D39721000 23 A at 240 V a.c. } D39722000
Fuse	The unit is self-protecting and has no user replaceable fuse. The unit will recover once any overload is removed.
Overvoltage category	2
Earth Stud	M4

### 2.2 Operating and storage data

Ambient operating temperature range	0 °C to 40 °C
Ambient storage temperature range	-30 °C to 70 °C
Maximum ambient operating humidity	Max 90% RH non condensing at 40 °C
Maximum operating altitude	3000 m max
IP rating	20
Pollution degree	2
Indoor use only	

### 2.3 Mechanical data

Weight	
TIC Turbo and Instrument Controller 100 W	1.8 kg
TIC Turbo and Instrument Controller 200 W	1.9 kg

## 2.4 Connections

### 2.4.1 Active gauge connectors

Connector type	FCC/RJ45, 8-way (refer to Figure 1)
Power supply	24 V d.c.
Maximum power rating	21 W total for the three gauges
Input voltage range	-0.5 V to 15 V
Output ID current	33 $\mu$ A, 0 V to 13 V
Control output	
Active	<0.8 V d.c. (2 mA max)
Inactive	open (internal pull-up to 24 V)
Control input	
Low	<2.0 V d.c. ( $I_{out}$ < 160 $\mu$ A)
High	>3.5 V d.c. (internally pulled up to 24 V)

Figure 1 - Pin connections for an 8-way FCC/RJ45

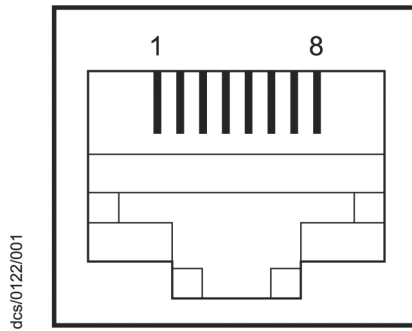

Table 2 - Gauge connector pin-out

Pin	Allocation
1	Power supply positive
2	Power supply common
3	Signal input
4	Identification
5	Signal common
6	Control line 1
7	Control line 2
8	N/C

## 2.4.2 Turbo pump connector

Connector type	15-way sub-miniature 'D' type socket (refer to Figure 2)
Power supply	24 V d.c.
Maximum output power	
100 W TIC	80 W continuous, 120 W peak
200 W TIC	160 W continuous, 240 W peak
	(combined total power of the 24 V turbo and backing pumps)
Input voltage range	-0.5 V to 15 V
Output ID current	33 $\mu$ A, 0 V to 13 V
Control output	
Active	<1.1 V d.c. ( $I_{out}$ 20 mA max) <0.8 V d.c. ( $I_{out}$ < 2 mA)
Inactive	open (<24 V d.c. externally applied)
Control input	
Low	<4.0 V d.c. ( $I_{out}$ <160 $\mu$ A)
High	7.0 V to 24 V d.c. (internally pulled up to 24 V)
RS232 transmit	
Disabled	open
Enabled	0: > +8 V ( $I_{out}$ max: 8 mA) 1: < -8 V ( $I_{out}$ max:- 8 mA)
RS232 receive	
Mark	<4.0 V d.c. ( $I_{out}$ < 160 $\mu$ A)
Space	7.0 V to 24 V d.c. (internal pull up to 24 V)
Maximum cable length	7 m

Figure 2 - Pin connections for a 15-way sub-miniature 'D' type socket

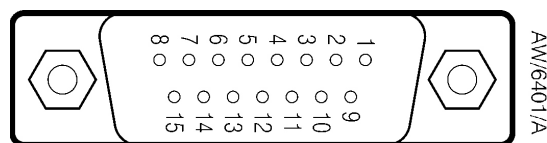

Table 3 - Turbo pump connector pin-out

Pin	Allocation
1	Power supply positive
2	Signal common
3	/Start signal output
4	RS232 Tx
5	/Serial enable output
6	Power supply positive
7	RS232 Rx
8	Power supply common
9	Speed signal input
10	Screen

Table 3 - Turbo pump connector pin-out (continued)

11	Power supply positive
12	Screen
13	Power supply common
14	Power supply common
15	Normal signal input

**2.4.3 Backing pump connector**

*Note: Only applicable to the 200 W TIC*

Connector type	15-way sub-miniature 'D' type socket (refer to Figure 3)
Power supply	24 V d.c.
Maximum output power	160 W continuous, 240 W peak (combined total power of the 24 V turbo and backing pumps)
Output voltage range	
Stop	0 V
Start	10 V (5 mA maximum)
Output ID current	33 µA, 0 V to 13 V
Control output	
Active	< 1.1 V d.c. ( $I_{out} < 20 \text{ mA}$ ) < 0.8 V d.c. ( $I_{out} < 2 \text{ mA}$ )
Inactive	open (< 24 V d.c. externally applied)
Control input	
Low	<4.0 V d.c. ( $I_{out} < 160 \text{ µA}$ )
High	7.0 to 24 V d.c. (internally pulled up to 24 V)
RS232 transmit	
Disabled	open
Enabled	0: > +8 V ( $I_{out} \text{ max: } 8 \text{ mA}$ ) 1: < -8 V ( $I_{out} \text{ max: } -8 \text{ mA}$ )
RS232 receive	
Mark	< 4.0 V d.c. ( $I_{out} < 160 \text{ µA}$ )
Space	7.0 V to 24 V d.c. (internal pull up to 24 V)
Maximum cable length	7 m

Figure 3 - Pin connections for a 15-way sub-miniature 'D' type socket

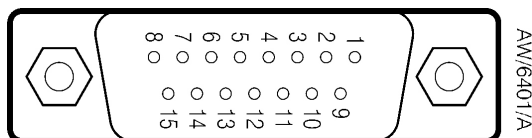

Table 4 - Backing pump connector pin-out

Pin	Allocation
1	Power supply positive
2	Signal common
3	/Start signal output
4	RS232 Tx
5	/Serial enable output
6	Power supply positive
7	RS232 Rx
8	Power supply common
9	Speed signal output
10	Screen
11	Power supply positive
12	Screen
13	Power supply common
14	Power supply common
15	Normal signal input

#### 2.4.4 Auxiliary terminals

Connector type	4-way screw terminal block (refer to Figure 4)
Wire size	1.5 mm <sup>2</sup> max
Power supply	24 V d.c.
Maximum output power	
Fan	3 W max
Vent valve	2 W max
Control output	
Active	<1.5 V d.c.
Inactive	open
Maximum cable length	10 m

Figure 4 - 4-way screw terminal block

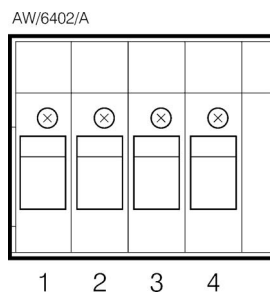
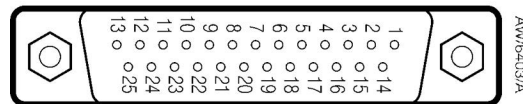

**Table 5 - Auxiliary connector pin-out**

Pin	Allocation
1	Fan control output
2	Fan 24 V
3	Vent control output
4	Vent 24 V

### 2.4.5 Logic interface

Connector type	25-way sub-miniature 'D' type socket (refer to Figure 5)
Power supply	24 V d.c.
Maximum output power	5 W
Control output	
Active	< 1.1 V d.c. ( $I_{out} < 20$ mA) < 0.8 V d.c. ( $I_{out} < 2$ mA)
Inactive	open
Control input	
Low	< 2.0 V d.c. ( $I_{out} < 160$ $\mu$ A)
High	3.5 V to 24 V d.c. (internal pull up to 24 V)
Analogue output	0 to 10 V (5 mA max) 50 mV resolution

**Figure 5 - Pin connections for a 25-way sub-miniature 'D' type socket**

**Table 6 - Logic interface connector pin-out**

Pin	Allocation
1	Screen
2	Analogue output signal
3	Setpoint 1 output
4	Vent control output
5	Bakeout band control output
6	N/C
7	Power supply common
8	Backing pump control output
9	Gauge 1 enable input
10	Power supply common
11	Power supply positive
12	Power supply common
13	Power supply common
14	Analogue output common

Table 6 - Logic interface connector pin-out (continued)

15	Setpoint 2 output
16	Setpoint 3 output
17	Turbo normal output
18	Alarm output
19	Air cooler output
20	Gauge 2 enable input
21	Gauge 3 enable input
22	Backing pump enable input
23	Turbo stand-by control input
24	Turbo pump enable input
25	System interlock input (SYSI)

### 2.4.6 Serial communications

Connector type	9-way sub-miniature 'D' type socket (refer to Figure 6)
RS232 transmit	
Mark	< - 8 V ( $I_{out}$ max: -8 mA)
Space	> +8 V ( $I_{out}$ max: -8 mA)
RS232 receive	
Mark	< +1.0 V ( $I_{in}$ max: -2.0 mA)
Space	>+2.0 V ( $I_{in}$ max: +2.0 mA)
Maximum input	$\pm 12$ V
RS232 protocol	9600 baud, 1 stop bit, 8 data bits, no parity
RS485	
Output differential	>1.5 V ( $I_{out}$ max: $\pm 25$ mA)
Input differential threshold	> $\pm 0.2$ V ( $I_{in}$ max: $\pm 1$ mA)
Maximum input	-7.0 V to +12 V
Bus load	The TIC applies one unit load to the RS485 bus.

Figure 6 - Pin connections for a 9-way sub-miniature 'D' type socket

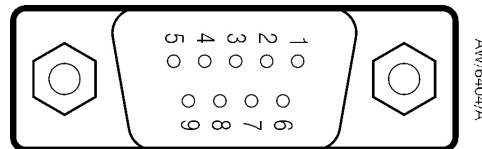

Table 7 - Serial communications connector pin-out

Pin	Allocation
1	N/C
2	RS232 transmit
3	RS232 receive
4	N/C
5	RS232 common
6	N/C
7	N/C
8	RS485 data A
9	RS485 data B



## 3 Installation

### 3.1 Unpack and inspect

Remove all of the packaging material and check the controller. If the controller is damaged, follow the Edwards return of equipment procedures that are laid out in the back of this manual. Do not use the controller if it is damaged.

Check that the package contains the items that are listed in Table 8. If any of these items are missing, notify the supplier in writing within three days. If the controller is not to be used immediately, store the controller in suitable conditions as described in [Section 6.1](#).

Table 8 - Checklist of components

Quantity	Description	Check (✓)
1	Controller	<input type="checkbox"/>
1	Quick Guide and Health and Safety Information	<input type="checkbox"/>
1	TIC CD	<input type="checkbox"/>
2	Rear non-slip feet	<input type="checkbox"/>
1	Logic interface plug	<input type="checkbox"/>

### 3.2 Fitting the controller



#### WARNING

If access to the IEC connector is restricted an additional isolation device should be provided, which will be easily accessible by an operator.

#### CAUTION

Rubber feet must be fitted ([Figure 7](#), item 1) so that there are correct clearances for air circulation. If not, the performance of the controller may be affected at high operating temperatures.

The controller can be used on a bench top or can be fitted in a rack or cabinet. [Figure 7](#) shows the dimensions of the TIC that are required for bench top use.

**Note:** If the interlocks are not used, the logic interface adaptor must be fitted to the 25-way connector.

Figure 7 - Dimensions of a bench mounted TIC (mm)

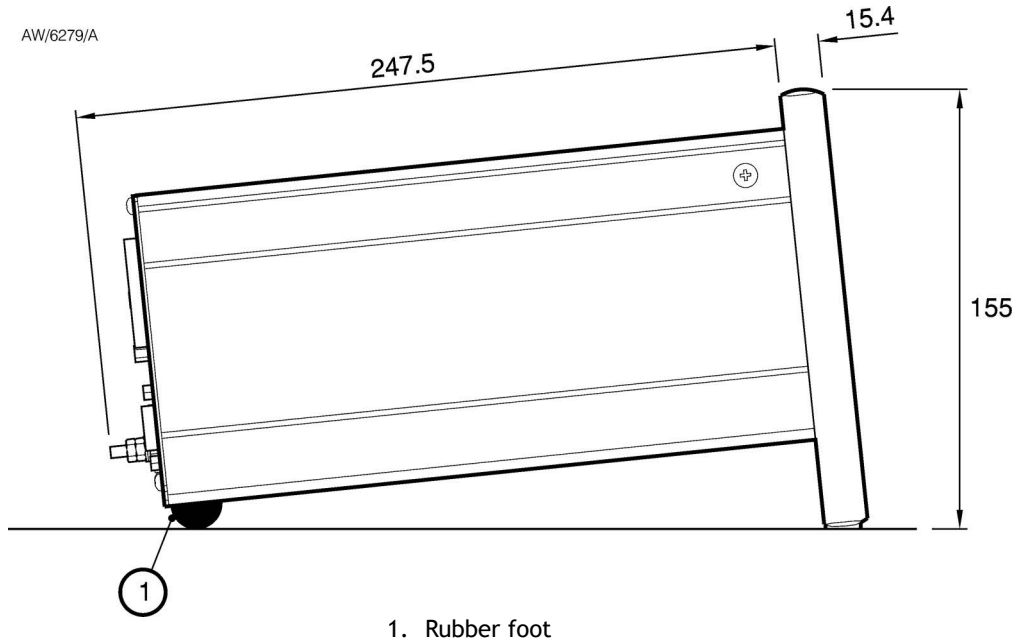

**WARNING**

Ensure that all electrical wiring is safely secured so that people cannot trip on them.

If a controller is fitted in a rack, cabinet or panel, follow the directions given in [Figure 8](#), [9](#) and [10](#).

**CAUTION**

Allow 150 mm at the rear for cables. Allow 50 mm top and bottom and 15 mm to the sides for sufficient air circulation. Do not cover any of the ventilation holes.

**CAUTION**

This unit is IP20 rated. Please ensure that the unit is not installed where fluids can enter into the controller.

**CAUTION**

The unit must be supported at the rear.

**Figure 8 - Front panel removal**

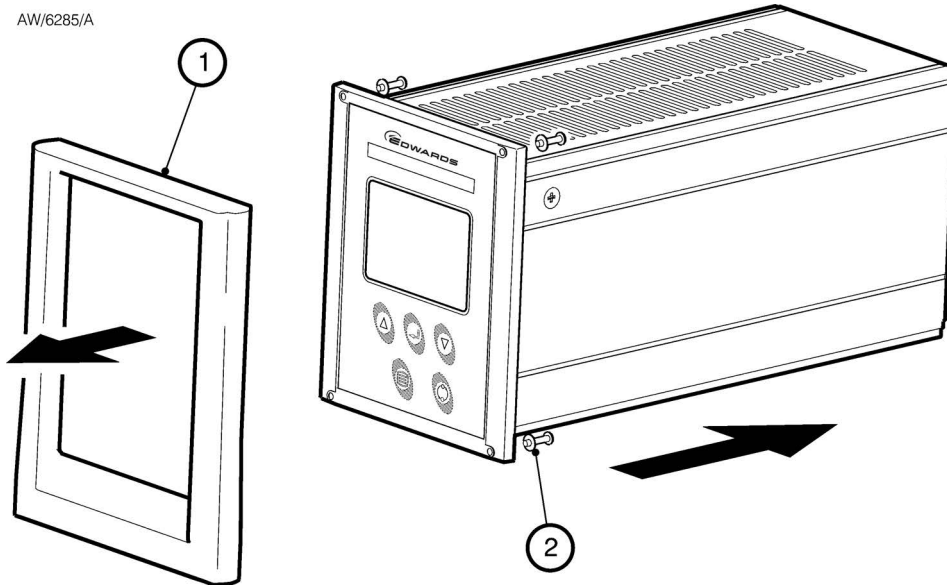

1. Bench top adaptor
2. Fixing screw and washer

- Remove the bench top adaptor (Figure 8, item 1) by removing the four screws (Figure 8, item 2).
- Slide the controller into the 19" rack or panel cutout. The use of 19" rack guide rails (Figure 9, item 2) and support at the rear of the controller is recommended as shown in Figure 9. The panel cutout information is defined in Figure 10.
- Fix the controller in place using the four screws removed previously (Figure 9, item 1).

**Figure 9 - Rack mounting of a TIC**

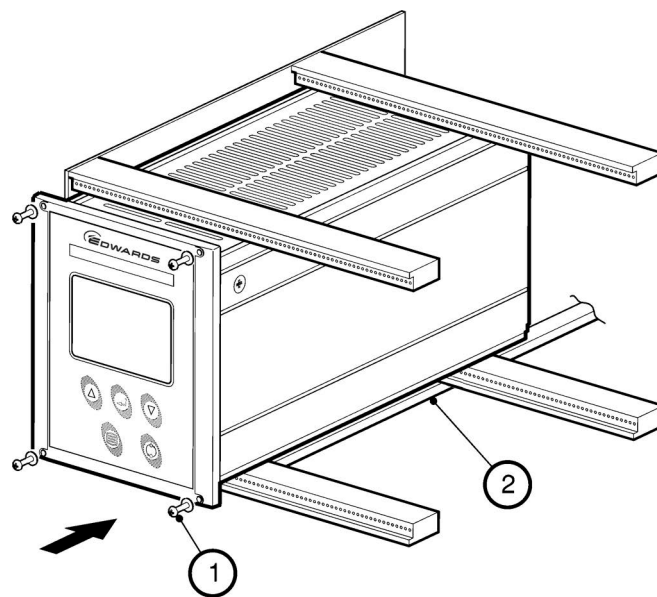

1. Fixing screw and washer
2. 19" rack guide rails

Figure 10 - Panel cutout drawing

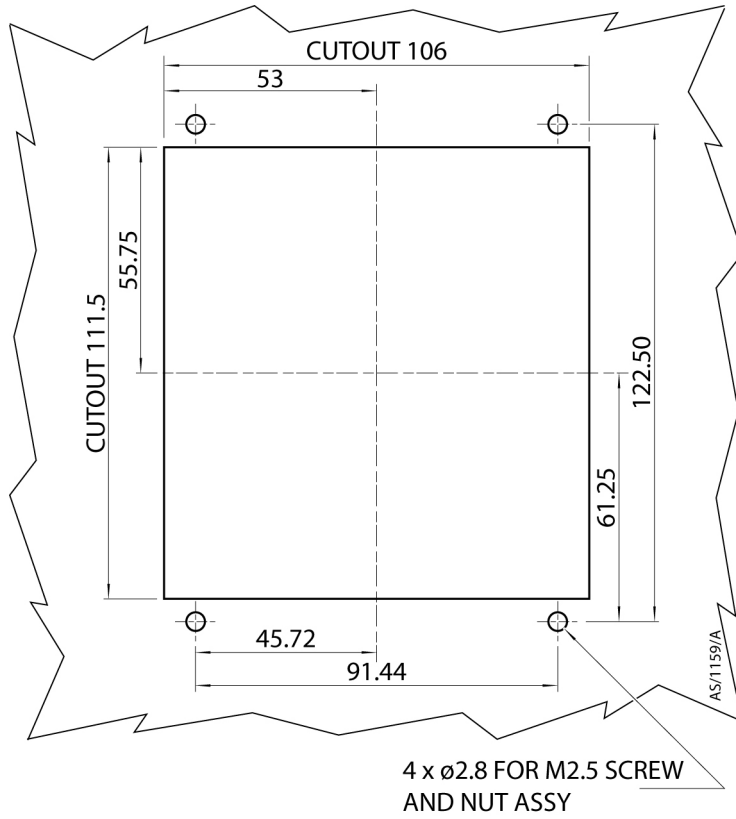

### 3.3 Controller electrical connections

---

**CAUTION**

Do not connect Barocel capacitance manometers to the TIC. Doing so will result in damage to the gauge and will invalidate the warranty.

---

Figure 11 - Rear panel connections

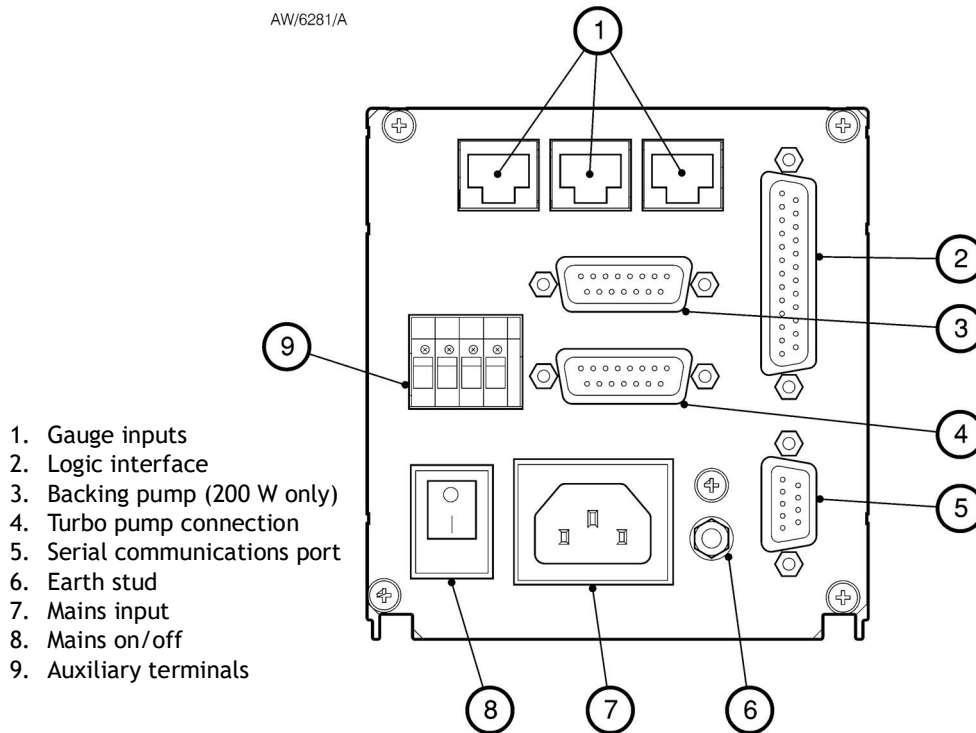

### 3.3.1 Connecting the electrical supply



#### WARNING

High voltages exist in the controller when it is operating. Ensure that the controller is earthed and observe all appropriate safety precautions for the safe installation and handling of electrical equipment. If not, there will be a danger of injury or death to people by electric shock.

Ensure that the electrical supply switch is set to 'off' and then connect the TIC to the electrical supply with an appropriate supply cable.

### 3.3.2 Additional earth bonding

The electrical supply cable normally provides protective earthing for electrical safety. If this is not the case, or if additional earth bonding is required, then the earth stud on the rear of the controller (Figure 11, item 6) should be connected to the vacuum system earth.

The earth connection of any vent valves or air coolers should also be connected to this earth stud to ensure that they are adequately earthed.

Connect a suitably earthed cable between the two nuts fitted to the earth stud on the rear of the TIC.

**Note:** Do not remove the bottom nut from the earth stud.

### 3.3.3 Connecting an active gauge

---

#### CAUTION

Do not connect Barocel capacitance manometers to the TIC. Doing so will result in damage to the gauge and will invalidate the warranty.

---

Up to three compatible active gauges can be fitted to the gauge connectors on the rear panel. Connect the gauges using Edwards active gauge cables to each of the three gauge sockets on the rear of the TIC.

**Note:** Only one AIGX gauge can be connected to the TIC at a time.

### 3.3.4 Connecting a turbo pump

---

#### CAUTION

Pumps are not hot swap safe unless explicitly stated in their manual. Before connecting or disconnecting a pump to the TIC, turn the power off. Failure to do so may damage the pump.

---

The TIC will only identify the pump connected at power on.

A suitable turbo pump can be connected to the TIC turbo pump connector on the rear panel.

Connect the pump to the lower of the two 15-way 'D' connectors and tighten the locking screws to ensure the connector cannot come loose.

### 3.3.5 Connecting a backing pump

Both the 100 W and 200 W TICs can control a mains backing pump via the logic interface. For details of this, refer to [Section 3.3.8.3](#).

The 200 W TIC can also drive a suitable backing pump from its second rear panel pump connector.

Connect the pump to the upper of the two 15-way 'D' connectors and tighten the locking screws to ensure the connector cannot come loose.

**Note:** To control an XDD1 24 V backing pump, the pump must be configured for 'analogue speed control'. Refer to the pump instruction manual for details on how to configure the pump for this operating mode.

**Note:** To utilise the remote start/stop of XDS35i, you will require a 15-way D-Type gender changer to be fitted to the pump when using Edwards standard connection cables.

### 3.3.6 Connecting a vent valve

A vent valve can be driven from either the auxiliary terminals on the rear of the TIC, or from the logic interface. For details of using the logic interface to control a vent valve, see [Section 3.3.8.3](#).

**Note:** If a DX or nEXT pump is to be used, it is recommended that the vent valve is connected to the pump, not the TIC Controller. If two vent valves are required, both the DX and TIC vent outputs can be used at the same time. (Refer to [Table 12](#)).

Connect the positive lead of the vent valve to the terminal marked 'Vent +', connect the negative lead of the vent valve to the terminal marked 'Vent -', and clamp the earth wire between the earth stud locking nuts on the rear of the controller. Ensure the screws and the earth terminal locking nut, are all firmly tightened.

### 3.3.7 Connecting an air cooler

An air cooler can be driven from either the auxiliary terminals on the rear of the TIC, or from the logic interface. For details of using the logic interface to control an air cooler, refer to [Section 3.3.8.3](#).

Connect the positive lead of the air cooler to the terminal marked 'Fan +', connect the negative lead of the air cooler to the terminal marked 'Fan -', and clamp the earth wire between the earth stud locking nuts on the rear of the controller. Ensure the screws and the earth terminal locking nut are all firmly tightened.

### 3.3.8 Connecting the logic interface

#### 3.3.8.1 Introduction

**Note:** In most applications, it will be preferable not to earth the logic interface power supply common to prevent earth loops inadvertently occurring.

---

#### CAUTION

Do not connect voltages greater than 24 V to the logic interface.

---

The logic interface provides a number of signals that can be used for monitoring the status of the vacuum system, and for controlling certain aspects of its operation. These signals can be broadly divided into two groups, control inputs and status outputs.

#### 3.3.8.2 Using control inputs

Control inputs provide a means of controlling the operation of the TIC and the associated vacuum system from external sources.

**Turbo Stand-by:** To cause the turbo pump to run at stand-by speed, link 'Turbo Stand-by' to 0 V. To return the pump to full speed, disconnect 'Turbo Stand-by' from 0 V. Note that only pumps that have stand-by speed capability will respond to this input.

**Turbo Enable:** The turbo enable input can be used to control the operation of the turbo pump. If turbo enable is open, the turbo pump cannot be started, and will stop if it is running. If turbo enable is connected to 0 V when power is applied to the TIC, the pump is able to start when commanded to do so. If turbo enable is connected to 0 V while the controller is operating, the turbo pump will start, as long as 'SYSI' and the software configuration allow it to do so.

**Backing Pump Enable:** The backing pump enable input can be used to control the operation of the backing pump. If backing pump enable is open, the backing pump cannot start, and will stop if it is running. If backing pump enable is connected to 0 V when power is applied to the TIC, the pump is able to start when commanded to do so. If backing pump enable is connected to 0 V while the controller is operating, the backing pump will start, as long as 'SYSI' and the software configuration allow it to do so.

**Gauge 1, 2, 3 Enable:** The gauge enable inputs can be used to control the operation of the gauges. If gauge enable is open, the associated gauge cannot be turned on, and will turn off if it is operating. To enable the gauges, connect the required gauge enable line to 0 V.

**Note:** Only gauges that can be turned on and off will respond to this input. Refer to the gauge manual for further details.

**SYSI:** The System interlock input can be used to interlock the TIC to a system fail or control signal. When 'SYSI' is open, all pumps will stop, the vent valve will be opened and gauges will turn off. The TIC will also trip into the fail condition. To clear the system interlock and allow the pumps and gauges to start, connect 'SYSI' to 0 V.



#### WARNING

'SYSI' is not fail safe and should not be relied upon for safety critical applications.

---

**Note:** Only gauges that can be turned on and off will respond to this input. Refer to the gauge manual for further details.

### 3.3.8.3 Using control outputs

Control outputs provide a means for the TIC to control external resources.

**Vent valve control:** The vent valve output can be used to control the operation of a vent valve. The 'Vent Valve' signal will be driven low to energise the valve when required. Connect the positive lead of the vent valve to '24 V' and the negative lead to 'Vent Valve Control'. The vent valve earth lead must be connected to 'Screen' or a suitable alternative earth point.

---

### CAUTION

**The vent valve output on the logic interface will not be maintained in the event of a power failure. If venting of the turbo pump while it is running at high speed is undesirable, use the vent valve output from the auxiliary terminals. This output will be maintained during a power failure.**

---

**Bakeout band control:** The bakeout band control can be used to switch a relay that can apply power to the band. The relay box has a relay built in for this purpose and provides connectors to allow power to be applied to the bakeout band. Refer to the relay box instruction manual for further information on driving a bakeout band.

To drive a relay without a relay box, connect the coil of a suitable 24 V relay between 'Bakeout Band Control Output' (negative) and 'Power Supply Positive' (positive).

**Backing pump control:** The backing pump control can be used to switch a relay that can apply power to a mains backing pump. The relay box has a relay built in for this purpose and provides a connector that will switch the pump on and off. Refer to the relay box instructions for further information on driving a backing pump.

To drive a relay without a relay box, connect the coil of a suitable 24 V relay between 'Backing Pump Output' (negative) and 'Power Supply Positive' (positive).

**Air cooler:** The air cooler output can be used to control the operation of an air cooler. The air cooler signal will be driven low to energise the cooler when required. Connect the positive lead of the cooler to the power supply positive and the negative lead to 'Air Cooler Control'. The air cooler earth lead must be connected to 'Screen' or a suitable alternative earth point.

### 3.3.8.4 Using status outputs

Status outputs provide a means for external systems to react based upon the current state of the TIC.

**Analogue output:** The analogue output provides a 0 V to 10 V signal that can be configured to represent system pressure, pump speed etc. Refer to [Section 4.8](#) for how to configure this output.

To connect this output to an external system, connect the 'Analogue Output Signal' to the positive input of the system and 'Analogue Output Common' to the negative side.

**Relay setpoint:** The setpoint outputs can be used to interface to external logic or can be used to drive relays. Each output can be configured in software to activate at a certain pressure or pump speed. Refer to [Section 4.15](#) for how to configure these outputs. Each relay can be manually controlled. Refer to [Section 4.5](#).

The relay box has built-in relays that can switch external loads and provides a connector to interface to an external system. Refer to the relay box instructions for further information on using the setpoint outputs.

To drive a relay without a relay box, connect the coil of a suitable 24 V relay between 'Setpoint Output' (negative) and 'Power Supply Positive' (positive).

**Turbo normal speed:** Turbo normal speed can be used to interface to external logic or can be used to drive a relay. This output is normally inactive and will become active when the turbo pump has reached its defined 'Normal' speed.

To drive a relay, connect the coil of a suitable 24 V relay between 'Turbo Normal Output' (negative) and 'Power Supply Positive' (positive).



**Alarm:** Alarm can be used to interface to external logic or can be used to drive a relay. This output is normally active and will become inactive in the event of an alarm condition.

To drive a relay, connect the coil of a suitable 24 V relay between 'Alarm Output' (negative) and 'Power Supply Positive' (positive).

### 3.3.9 Connecting the serial interface

The TIC has two serial communications protocols built in, RS232 and RS485. RS232 is the simplest interface and can be used to allow a host PC to control the TIC. RS485 allows a host PC to control a small network of TICs.

#### 3.3.9.1 Connecting RS232

The TIC is fitted with a 9-way 'D' type socket on the rear panel. The interface uses two lines for data transfers and an additional line as a signal common. Hardware handshaking is not implemented.

If connecting to an IBM compatible PC fitted with a 9-way 'D' type socket then a 'straight through' male-female 9-way extension cable can be used to connect the TIC to the computer as shown in Figure 12. Connection to an IBM PC fitted with a 25-way serial connector should be made as shown in Figure 13.

Use shielded cable for the interface to reduce interference problems and limit the length of the RS232 link to less than 10 metres. For longer links, either install line drivers or use RS485.

Figure 12 - IBM PC RS232 interface - 9-way

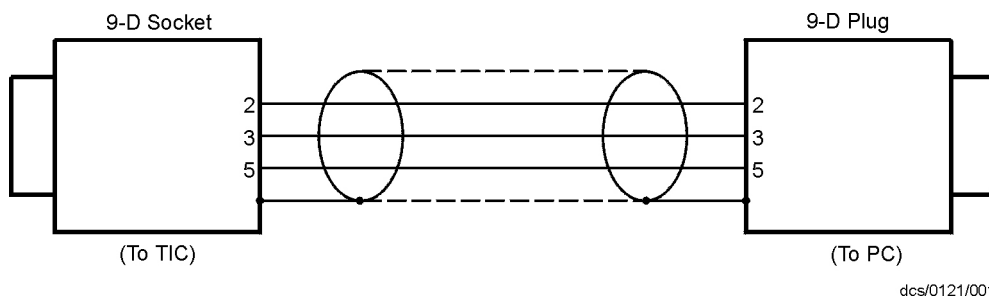
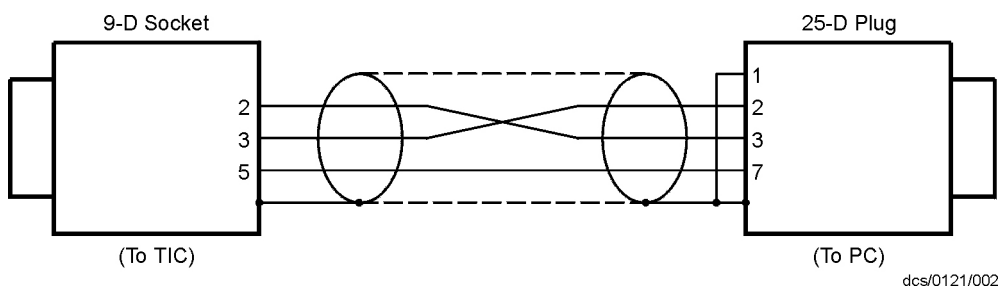

Figure 13 - IBM PC RS232 interface - 25-way



#### 3.3.9.2 Connecting RS485

RS485 provides the TIC with the capability to be networked with other TICs and a host PC as shown in Figure 14.

### CAUTION

All of the ground connections are tied together. If differences exist in the local ground voltage, damage could occur. If the TICs being networked are liable to experience different ground potentials, a suitable RS485 isolator should be connected between them.

Use shielded cable for the interface to reduce interference problems and limit the length of the RS485 link to less than 1000 metres.

Long links may require the addition of 120 Ω terminating resistors at each end of the link to improve communications reliability.

Figure 14 - RS485 TIC network

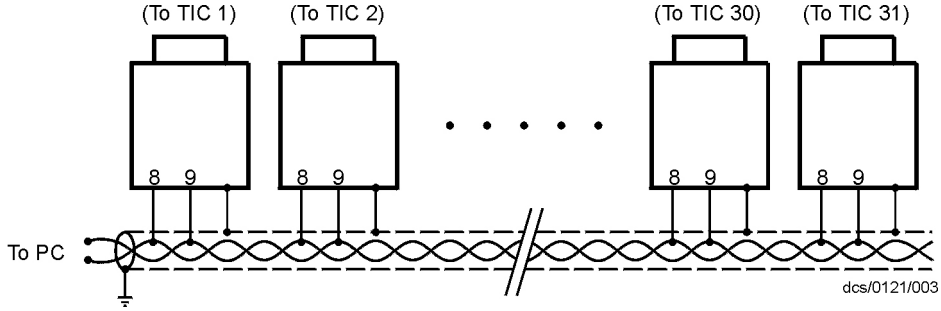

## 4 Operation

### 4.1 Front panel description

Figure 15 - Front panel display

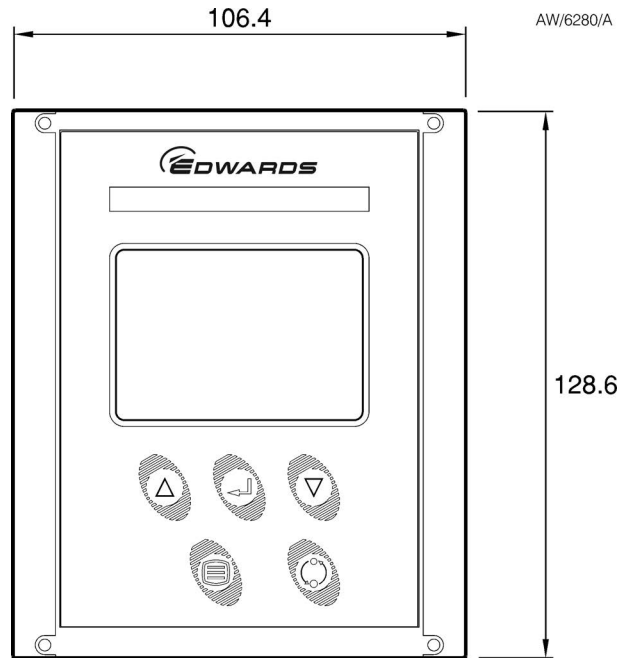

Table 9 - Front panel symbols and their functions

Symbol	Name	Function
	UP	Move up through a menu. Cycle selected numerical values up. Cycle a selected list item upwards.
	DOWN	Move down through a menu. Cycle selected numerical values down. Cycle a selected list item downwards.
	SELECT	Enter the highlighted sub-menu. Edit the highlighted list or numerical item. Move to the next digit of a numerical value. Jump to the setup screen for the highlighted gauge or pump.
	MENU	Switch between the default view screen and the main menu. Exit the current sub-menu or setup screen. Abort edit of a selected list item. Move to the previous digit of a numerical value.
	CYCLE	Turn a highlighted gauge or pump on or off.

### 4.2 Menu structure

Figures 16 and 17 show the view screen shortcuts and menu structure for the TIC. They also give an indication as to what buttons will lead where within the menu layout.

Figure 16 - View screen shortcuts

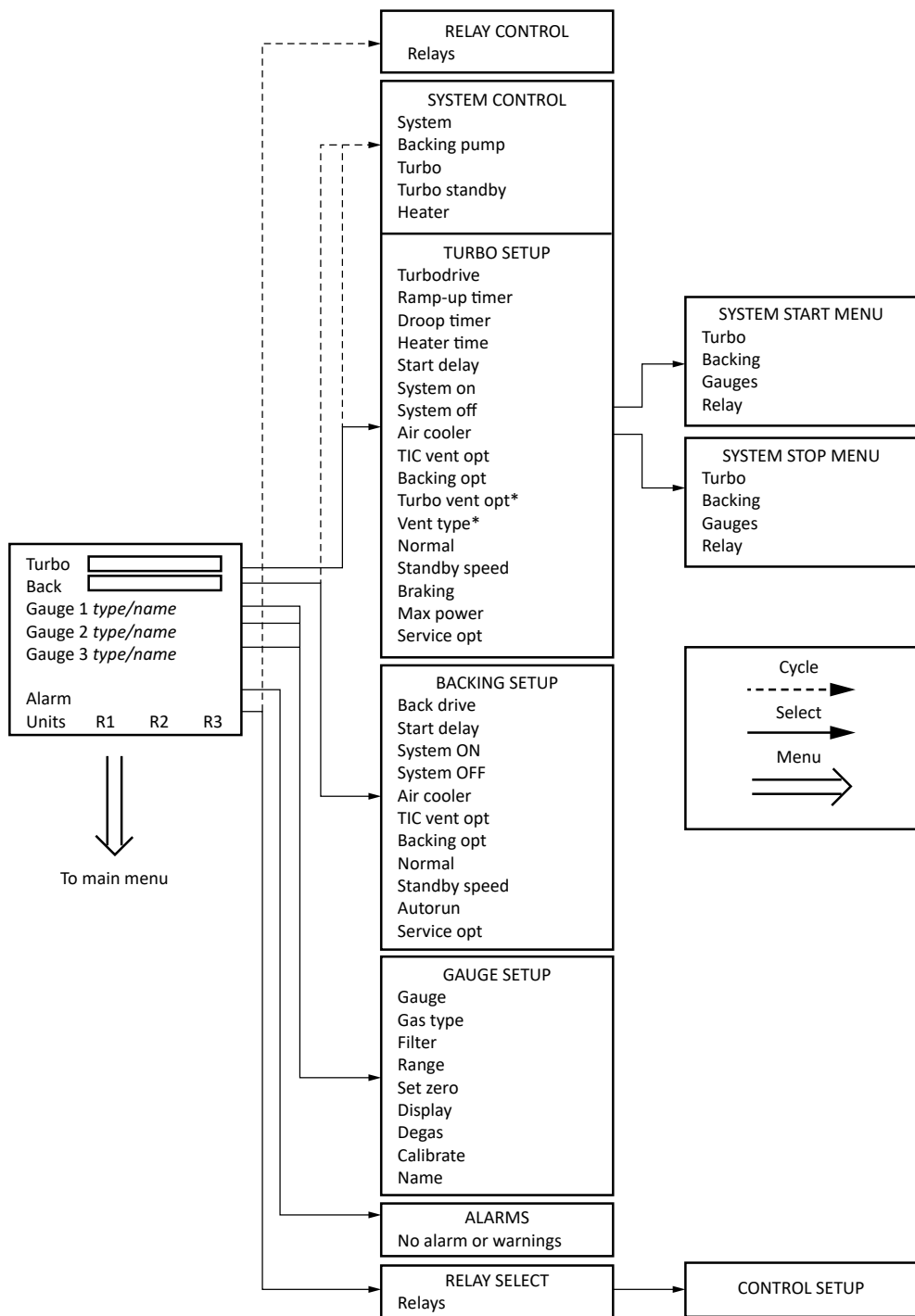

CS/1352/A

\* As applicable, see Section 4.8.3 for more information.

Figure 17 - Menu structure

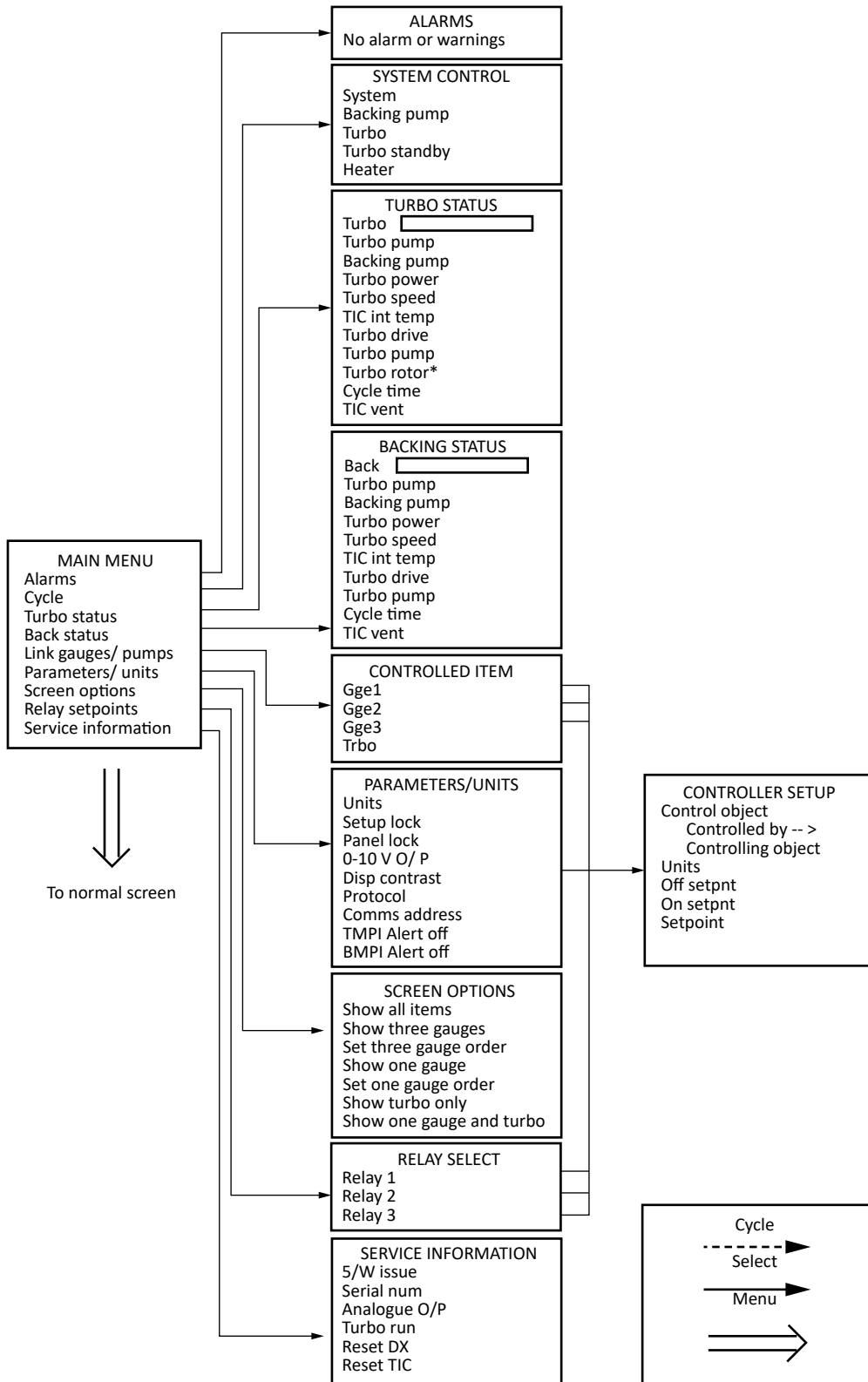

CS/1353/A

\* nEXT85 family only, see Section 4.13 for more information.

### 4.3 Navigating the menu

This section summarises the display navigation method for the TIC. There are 4 buttons for menu navigation and configuration tasks. A fifth button is used for switching pumps/gauges ON and OFF. In most configuration tasks, there are no more than three menu levels.

Refer to [Table 9](#) for a description of the functions performed by the front panel buttons.

### 4.4 The view screen

The view screen can be set to various view options; refer to [Section 4.16](#) for the various view screen options that can be set. The following describes the view screen that shows 'all'. (Refer to [Figure 18](#)).

The top portion of the view screen shows the status of the vacuum pumps; the top line shows the pump speed as a bar chart. In the top right-hand corner the status of the turbo pump is shown as follows:

- Off. The turbo pump is off.
- >>>. The turbo pump is accelerating.
- <<<. The turbo pump is decelerating.
- Run. The turbo pump is above 50% speed.
- Norm. The turbo pump is at or above 'normal speed'.
- Strt. The turbo pump is enabled to start, but will not run until the start delay has run down.
- Flt. An error has occurred. Select the alarms screen.

The second line shows the information for the backing pump in the same format as that used for the turbo pump.

The status of the setpoint relays is shown at the bottom line of the view screen. Relays that are on are shown in reverse video.

Active gauges are fitted with a resistor that is unique to the type of gauge. When a new gauge is connected, TIC automatically identifies the gauge and indicates that a new gauge has been detected by displaying 'New ID' as shown in [Figure 18](#).

Figure 18 - View screen

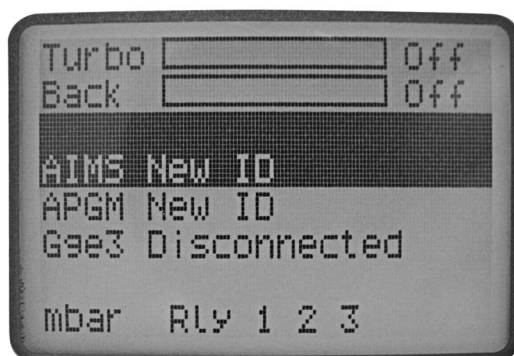

In this example, new gauges have been plugged into channels 1 and 2. Scroll up/down (  $\Delta$  /  $\nabla$  ) to the selected gauge channel and press the 'Select' (  $\leftarrow$  ) button. The display will identify the gauge type and display either an output or message. Gauges, which measure up to atmospheric pressure (high pressure gauges), will automatically display an output.

## 4.5 Turning gauges, pumps and relays on/off

**Note:** If the view screen has been setup to show gauges only, the system can be turned on and off by accessing the cycle menu item in the main menu.

Pressing the 'Cycle' (⊙) button with view screen items selected will turn the items 'on/off'. If the selected item is the turbo/backing status line, a menu of switchable items appear. Use the 'Cycle' (⊙) button to switch the item.

Figure 19 - Gauge output displayed



Low pressure gauges (AIGX and AIM) default to 'OFF', as they should not be operated at pressures greater than their upper range limit. Low pressure gauges may be switched on manually, by scrolling to the display line and pressing the 'Cycle' (⊙) button, or they may be linked to and protected by a suitable high pressure gauge (refer to Section 4.15).

If the selected item is the relay status line, a list of the relays will appear. Scroll to the required relay and use the 'Cycle' (⊙) button to switch the item. When the relay is activated, the annunciator on the view screen will change to reverse video.

**Note:** Low pressure gauges must be 'enabled' by the Logic Interface before TIC can turn them ON and OFF. This is done either by fitting a link across the appropriate pins on the mating connector, or using an external switch.

The logic interface plug supplied with the TIC has links for this purpose.

If System Interlock (SYSI) is active, pressing the 'Cycle' (⊙) button will not switch on low pressure gauges. Conversely, if SYSI is opened during the vacuum cycle, all connected controllable components will be switched OFF.

## 4.6 Changing list items

To change a list item, scroll to the required line and press the 'Select' (↵) button. The list can then be scrolled using the up and down arrows (△ / ▽).

Pressing the 'Select' (↵) button will accept the adjustment and return the highlight to the row item, allowing another item to be selected for adjustment.

Pressing the 'Menu' (☰) button will cancel the adjustment and return the highlight to the row item, allowing another item to be selected for adjustment.

## 4.7 Changing numerical values

To change a numerical item, scroll to the required line and press the 'Select' ( $\leftarrow \downarrow$ ) button. The first number will then be highlighted and can be changed using the up and down arrows ( $\triangle / \nabla$ ).

The 'Select' ( $\leftarrow \downarrow$ ) button will move the highlight to the next digit with each successive press, allowing the complete number to be entered. Pressing the 'Select' ( $\leftarrow \downarrow$ ) button with the last digit selected will accept the adjustment and return the highlight to the row item, allowing another item to be selected for adjustment.

At any time, mistakes can be corrected by pressing the 'Menu' ( $\text{☰}$ ) button. This will move the highlight to the previous digit with each successive button press, allowing corrections to be made. Pressing the 'Menu' ( $\text{☰}$ ) button with the first digit selected will cancel the adjustment and return the highlight to the row item, allowing another item to be selected for adjustment.

Figure 20 - Changing numerical values

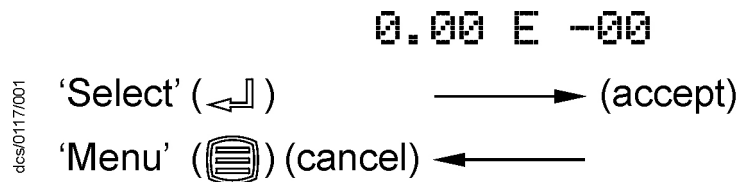

### 4.7.1 Entering negative components e.g. 5.00E-03

To enter a negative exponent, first enter the number then change the sign of exponent. For example, to enter 5.00E-03:

First enter the number using the ( $\triangle / \nabla$ ) and ( $\leftarrow \downarrow$ ) buttons as above

5.00E + 03

Then use the 'menu' ( $\text{☰}$ ) button to move to the + character

5.00E + 03

Use the ( $\triangle / \nabla$ ) buttons to change the character to -

5.00E - 03

Finally, press the 'select' ( $\leftarrow \downarrow$ ) button three times to complete the entry

5.00E - 03

The entry is now complete. Use the ( $\triangle / \nabla$ ) button to move to the next list item or the 'menu' ( $\text{☰}$ ) button to return to other menus.



## 4.8 Turbo setup

### CAUTION

All setups in the TIC are held in non-volatile memory. Non-volatile memory has a limit on the number of times its contents can be changed. Current minimum lifetime is 100,000 changes on a particular section. This equates to more than 1 change per hour every hour for 10 years. If the number of changes is exceeded, random data may be stored leading to unexpected system behaviour.

### 4.8.1 Introduction

The TIC can be used to configure the EXT, DX and nEXT pump ranges. The menu screen shows differing functionality depending on the pump attached. The TIC will recognise the pump attached and show it on the pump setup and pump status screens. (Refer to Figure 21).

Figure 21 - Turbo setup screen



### 4.8.2 Default turbo setup options

Table 10 - Default turbo setup options

Menu option	Description
Ramp Up Timer	The user can set the ramp up timer from 1 to 30 minutes. This timer will generate an alarm if the pump speed does not rise above 50% speed after the set time.
Droop Timer	The user can set the droop time from 1 to 30 minutes. This timer will generate an alarm if the pump speed drops below 50% speed for longer than the specified time.
Heater time	The user can set the time that the heater band bakes out the turbo pump from 0 to 35 hrs. The heater will come on for the set time, once the pump reaches 'normal speed'. If the pump drops below 'normal speed', the heater band will switch off and the timer will be reset. Once the heater band is operating, the user can interrupt and restore heater band operation through the serial interface or the TIC front panel.
Start delay	The start delay enables the user to delay the start of the turbo pump from 0 to 99 minutes.
System ON	Allows the user to define the components of the system that are to be turned on, when the 'system' is cycled on.

Table 10 - Default turbo setup options (continued)

Menu option	Description
System OFF	<p>Allows the user to define the components of the system that are to be turned off, when the 'system' is cycled off.</p> <p><i>Note:</i> The system ON and OFF commands provide manual control of the items listed. Where possible it will override settings such as backing options and gauge linking.</p> <p><i>Note:</i> If the backing pump option has been set to 50% or on stop, 'seq' will be indicated showing the backing pump is sequenced to one of the options.</p>
Air cooler	The user can set when an Edwards air cooler should operate. The air cooler can be set to 'ON' (on permanently) or 'Turbo' (on when the turbo pump is running).
TIC vent options	A vent valve attached to the TIC can be operated in the following ways: 'On stop' to open the vent valve 2 seconds after the stop command, or '50%' to open the vent valve when the pump slows to 50% speed.
Backing pump options	<p>A backing pump attached to the TIC or via a relay box can be operated in the following way:</p> <p>None: The backing pump is not sequenced to the Turbo pump</p> <p>50%: The backing pump will turn off after 2 seconds, once the turbo speed has dropped to 50% of its speed. The delay allows detritus to be removed from the system.</p> <p>On stop: The backing pump will turn off 4 seconds after the Turbo off command has been sent. The 4 second delay allows shutting of a valve and then removal of detritus from the system.</p>

Please refer to Table 11 for error and diagnostic information for pumps.

**CAUTION**

If an Edwards 24 V backing pump is connected, it is advised that the overall power used does not exceed the data specified in Section 2.

Table 11 - Error/diagnostic monitoring, turbos

Diagnostic messages	Description
RampUp Timeout	<p>Check whether the pump is too hot or whether the inlet pressure is too high.</p> <p>Check that the backing pump is operational.</p> <p>Check the vacuum system for leaks.</p>
Droop Timeout	<p>Check whether the pump is too hot or whether the inlet pressure is too high.</p> <p>Check that the backing pump is operational.</p> <p>Check the vacuum system for leaks.</p>

**4.8.3 Additional setup options using a DX or nEXT pump**

The TIC allows the user to set up additional functionality available within a DX or nEXT pump.

**CAUTION**

Read the DX or nEXT pump manual before using the TIC to set up the DX or nEXT pump.

Turbo venting can be set for different pump families as per Table 12. The user may also use the TIC vent option to enable an extra vent valve to be connected to a vacuum system.

Table 12 - Turbo pump vent setup differences

Pump Family	Turbo vent option (1)	Turbo vent option 2	Turbo vent type 1	Turbo vent type 2
DX	X			
nEXT85	X	X	X	X
nEXT240/300/400	X			

Table 13 - Turbo pump vent options

On screen	Description
50%	Vent valve opens fully below 50% full rotational speed for both Stop command or Fail <i>Note: This is the default factory setting.</i>
50%CvV	Controlled venting from 100% - 50% full rotational speed; Vent valve opens fully below 50% for both Stop command or Fail
STP50%	Vent valve opens fully immediately Stop command is received; Vent valve opens fully below 50% full rotational speed if Fail
STPCnV	Vent valve opens fully immediately Stop command is received; Controlled venting from 100% - 50% full rotational speed then vent valve opens fully below 50% if Fail
FLT50%	Vent valve opens fully immediately if Fail; Vent valve opens fully below 50% full rotational speed if Stop
FLTCnV	Vent valve opens fully immediately if Fail; Controlled venting from 100% - 50% full rotational speed then vent valve opens fully below 50% if Stop command received
STPFLT	Vent valve opens fully immediately for both Stop command or Fail
FLTSTP	Vent valve opens fully immediately for both Stop command or Fail
FAN	Vent is Permanently Enabled and can be used to provide power to an Edwards air cooler; This option cannot be set if the pump is above 50% full rotational speed
OPT 9	Do not use
OPT 10	Do not use

Table 14 - Turbo pump vent type

On screen	Description
N/O	Output configured for a normally open vent valve; this cannot be changed if the pump is above 50% full rotational speed
N/C	Output configured for a normally closed vent valve; this cannot be changed if the pump is above 50% full rotational speed

Table 15 - DX and nEXT pump setup options

Menu option	Description
Normal	The TIC allows 'normal speed' to be set as a percentage of full speed.
Standby speed	The user can set the standby speed as a percentage of full speed.
Max power	The user can set the maximum power a DX or nEXT pump can use.
Braking	Off/Enabled. The user can utilise this function to slow the turbo pump at a quicker rate.

Table 15 - DX and nEXT pump setup options

Menu option	Description
Service opt	nEXT service indication options. Podule flashing LED, fail line, both, none.

Please refer to Table 16 for the error and diagnostic information for DX, nEXT and nXDS pumps.

Table 16 - Error/diagnostic monitoring, DX, nEXT and nXDS pumps

Diagnostic messages	Description
Serial ID Fail	A DX, nEXT or serial pump is connected, however the type has not been recognised. Check that the leads are connected.
Turbo Fault	Review the flashing error codes on the pump podule, and refer to the DX or nEXT instruction manual.
SC Interlock	Serial enable to the DX or nEXT pump was lost while it was running. This could be caused by a temporary loss of power or a broken wire. It is recommended to stop the pump and then restart it. If the alarm does not clear, cycle the controller and then try again.
Uload Timeout	Check that the pump is correctly connected, then try to upload again.
Dload Failed	Check that the pump is correctly connected, then try to download again.
nEXT Service due warning	One of the nEXT items has exceeded its service interval. See nEXT Service screen for details. Contact Edwards for a suitable service kit or to arrange a service by Edwards.
nXDS Service due warning	One of the nXDS items has exceeded its service interval. See nXDS Service screen for details. Contact Edwards for a suitable service kit or to arrange a service by Edwards.

## 4.9 Backing setup

Table 17 - Default Backing setup options

Menu option	Description
Start delay	The start delay enables the user to delay the start of the turbo pump from 0 to 99 minutes.
System ON	Allows the user to define the components of the system that are to be turned on, when the 'system' is cycled on.
System OFF	Allows the user to define the components of the system that are to be turned off, when the 'system' is cycled off. <b>Note:</b> The system ON and OFF commands provide manual control of the items listed. Where possible, it will override settings such as backing options and gauge linking. <b>Note:</b> If the backing pump option has been set to 50% or on stop, 'seq' will be indicated showing the backing pump is sequenced to one of the options.
Air cooler	The user can set when an Edwards air cooler should operate. The air cooler can be set to 'ON' (on permanently) or 'Turbo' (on when the turbo pump is running).
TIC vent options	A vent valve attached to the TIC can be operated in the following ways: 'On stop' to open the vent valve 2 seconds after the stop command, or '50%' to open the vent valve when the pump slows to 50% speed.
Backing pump options	A backing pump attached to the TIC or via a relay box can be operated in the following way: None: The backing pump is not sequenced to the Turbo pump 50%: The backing pump will turn off after 2 seconds, once the turbo speed has dropped to 50% of its speed. The delay allows detritus to be removed from the system. On stop: The backing pump will turn off 4 seconds after the Turbo off command has been sent. The 4 second delay allows shutting of a valve and then removal of detritus from the system.

Table 18 - nXDS pump setup options

Menu option	Description
Normal	The TIC allows 'normal speed' of the backing pump to be set as a percentage of full speed.
Standby speed	The user can set the standby speed of the backing pump as a percentage of full speed.
Autorun	Sets the nXDS to start when power is turned on
Service opt	nXDS service indication options. Podule flashing LED, fail line, both, none.

## 4.10 Gauge setup

When a new gauge has been identified, scrolling to the selected gauge and pressing the 'Select' (↵) button accesses the 'Gauge Setup' screen. (Refer to Table 19).

Table 19 - Default setup options (all gauges)

Menu option	Description
Gauge	Indicates type of gauge connected.
Gas type	Allows the user to select the gas type. Choice of: N <sub>2</sub> , He, Ar, CO <sub>2</sub> , Ne, Kr or Volts.  <i>Note: For gas dependent gauges, it is important that the correct gas is selected to ensure correct pressure indication.</i>
Filter	Allows the user to select filter status. Filter 'OFF' gives pressure output as reported by the gauge (update rate 3 per second approx). Filter '1 sec' applies a one second moving average to the readings, reducing the effects of noise on reading stability.
Name	Allows the user to name gauges. 4 characters can be set appropriate to the system, A-Z, 0-9, _ (space).  <i>Note: If the gauge name is set the name will appear if the gauge is disconnected. To reset to the gauge type ensure 4 spaces appear in the gauge name setup.</i>

### 4.10.1 Default setup options (all gauges)

All gauges have the following default items on their respective setup screens. (The example below shows the APM as the connected gauge).

Figure 22 - Gauge setup screen

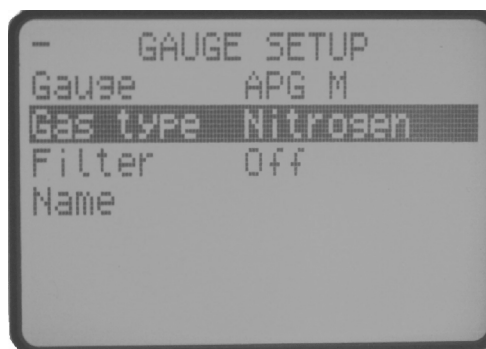

gea/TIC/f21

**Note:** Active Strain Gauges (ASG2) are gas independent. Selection of any gas type will give the same pressure output.

### 4.10.2 Gauge status messages

Standard status messages are shown in [Table 20](#).

**Table 20 - Gauge status messages**

Diagnostic messages	Description
Not Connected	Indicates that no gauge has been connected to TIC, or if a cable has been connected, the gauge may not be connected to the other end.
Disconnected	The gauge connection has been removed intentionally or accidentally.
New ID	Indicates that a new gauge has been connected to TIC. The gauge is recognised by TIC, but must be acknowledged by the user before TIC will allow the gauge to operate on the system.
Uknw	Indicates that the connected gauge is not recognised by TIC. In this case, TIC will continue to display the gauge as NFND and will give an output in volts only.

### 4.10.3 Active Pirani Gauge (APG)

For detailed instructions on APG gauges, see their associated manuals.

The APG series gauges are gas-dependent, high-pressure thermal conductivity gauges. The APGX-H is a convection version of Pirani gauge, which enables accurate measurement at atmospheric pressures. The display ranges are model dependent. Refer to [Table 21](#) for details.

**Table 21 - Display range**

Model Name	Display range
APG-M, APG-MP, APG-XM, APG100-M, APG100-MP, APG200-M, APG200-MP	1000 to 1e-3 mbar (750 to 7.5e-4 torr)
APG200-XM, APG200-XMP	1000 to 5e-4 mbar (750 to 3.75e-4 torr)
APGX-H	1333 to 3e-4 mbar (1000 to 2.3e-4 torr)
APG-L, APG-XL, APG100-LC, APG100-XLC, APG200-LC, APG200-XLC	1000 to 1e-4 mbar (750 to 7.5e-5 torr)

**Note:** At pressures above 600 mbar, sensitivity is reduced and the TIC displays atmospheric pressure.

**Note:** Before the APG is used, and periodically thereafter, atmosphere and vacuum calibration should be carried out in accordance with the directions shown in the associated instruction manual.

The APG series gauges are permanently enabled, meaning you will see pressure readings as soon as they are recognised by the controller. The APG series are set up as per the default gauge setup instructions shown in [Section 4.10.1](#). The Linear gauges (those with an "X" in the model name) have additional menu options to those shown in [Section 4.10.1](#) (Refer to [Table 23](#) and [Figure](#) ).

Table 22 - Error/diagnostic monitoring APG

Diagnostic messages	Description
Over Range	(Gauge output >11.000 V) Indicates that either the measured gas pressure is outside the range of the gauge, or that there is a fault with the gauge. Clear the error message, reduce the process pressure to within the range of the gauge, 'Scroll' to the gauge display line and press 'Cycle'. If the gauge fails to give a pressure readout it should be replaced. This is most likely to occur with gasses of low molecular weight such as Helium.
Under Range	(Gauge output <1.800 V) Indicates that there is either a calibration error, or the gauge is faulty. Calibrate the gauge as described in the instruction manual. If the fault persists, replace the gauge.

Table 23 - Setup options Linear APG gauges

Menu option	Description
Calibrate	Allows the user to adjust the Linear APG gauges at atmosphere and vacuum. Connect the Gauge to the Controller and allow it to operate at atmospheric pressure for at least 10 minutes. 'Scroll' to 'Calibrate' and press 'Select'. 'Command Sent' appears for 1 s to confirm instruction has been carried out. Reduce the system pressure to below 1e-5 mbar (7.5e-6 torr). Press 'Select'. 'Command Sent' appears after 1 second to confirm instruction has been carried out. Press 'menu' (☰) button to return to the display screen.

Figure 23 - Gauge setup screen APGX-M



gea/TIC/f22

APGX has a built-in error monitoring capability. (Refer to Table 24).

Table 24 - Error/diagnostic monitoring APGX

Diagnostic messages	Description
Over Range	(Gauge output = 9.750 V) Indicates that there is a fault with the gauge and it should be replaced.
Under Range	(Gauge output <0.300 V) Indicates that there is a fault with the gauge and it should be replaced.
Filament Fail	(Gauge output = 9.500 V) Indicates that the gauge filament is broken. The gauge should be replaced.

Table 24 - Error/diagnostic monitoring APGX (continued)

Diagnostic messages	Description
Cal Error	(Gauge output = 9.600 V) Indicates that the gauge has gone out of calibration. This could be because of the wrong gas type being selected, pressing the atmosphere and vacuum adjustment button in mid-range or contamination of the gauge. The gauge should be re-adjusted as described in Table 23. If the fault persists the gauge should be replaced.
No Tube	(Gauge output = 9.700 V) Indicates that the replaceable gauge tube is missing or incorrectly fitted. Check the tube and ensure that the two fixing screws are properly secured.  <i>Note:</i> APGX-H only.

*Note:* There is a +/- 50 mV tolerance on the gauge outputs shown in Table 24.

#### 4.10.4 Active Strain Gauge (ASG2) control

*Note:* For a detailed specification and instructions regarding the use of the ASG2, refer to the instruction manual (D35735880).

Active Strain Gauges are gas-independent diaphragm gauges. There are two gauges with full scales of 2000 and 1000 mbar (1500 and 750 Torr) respectively. Both gauges measure pressures down to 1 mbar ( $7.5 \times 10^{-1}$  Torr), have a linear pressure characteristic and output voltage directly proportional to the pressure. The output is 0 to 10 V d.c. over the measuring range of the gauge ASG2 has menu options in addition to those shown. (Refer to Default setup options (all gauges) Section 4.10.1. (Refer to Table 25 and Figure 24).

Table 25 - Setup options ASG2

Menu option	Description
Range	Indicates full scale of available gauge options. Choice of: 1000 or 2000
Set zero	Allows the user to zero the gauge. Reduce the system pressure to $2 \times 10^{-2}$ mbar ( $1.5 \times 10^{-2}$ Torr) or below for the 2000 mbar (1500 Torr) ASG2 or $1 \times 10^{-2}$ mbar ( $7.5 \times 10^{-3}$ Torr) or below for the 1000 mbar (750 Torr) ASG2. 'Scroll' to 'Set zero' and press 'Select'. 'Command Sent' appears for 1 s to confirm instruction has been carried out.
Display	Indicates pressure display options. Choice of: Float (mantissa and exponent). Fixed (number to 1 decimal place).

Figure 24 - Gauge setup screen ASG2



gea/TIC/f23



Please refer to [Table 26](#) for the error and diagnostic information for the ASG2.

**Table 26 - Error diagnostic monitoring ASG2**

Diagnostic message	Description
Over Range	(Gauge output >11.000 V) Indicates that either the measured gas pressure is outside the range of the gauge, or that there is a fault with the gauge. Clear the error message, reduce the process pressure to within the range of the gauge, scroll to the gauge display line and press 'Cycle'. If the gauge fails to give a pressure readout it should be replaced.
ASG2 Cant Zero	Indicates that the gauge output is outside the range -100 mV to +100 mV. The most likely cause of this error is either attempting to zero the gauge at too high a pressure or a gauge fault. Attempt to zero the gauge again and if the fault persists, the gauge should be replaced.

#### 4.10.5 Active Inverted Magnetron (AIM) Gauge control

**Note:** This section covers both standard (AIM-S) and linear (AIM-X) output gauges including low magnetic field (-SL or -XL) and bakeable (type DN40CF) versions.

**Note:** For a detailed specification and instructions regarding the use of the AIM-S and AIM-X gauges, refer to the appropriate instruction manual (D14641885 and D14661880).

Active Inverted Magnetron (AIM) gauges are gas-dependent, cold-cathode ionisation gauges that measure pressures in the range  $1 \times 10^{-2}$  to  $1 \times 10^{-9}$  mbar ( $7.5 \times 10^{-3}$  to  $7.5 \times 10^{-10}$  Torr). There are a number of variants, offering standard (AIM-S) and linear (AIM-X) outputs, low external magnetic field (AIM-SL and AIM-XL) variants for use on sensitive scientific instruments and special bakeable tubes for use in UHV applications.

There are no additional setup options for AIM. (Refer to Default setup options (all gauges) [Section 4.10.1](#).)

Please refer to [Table 27](#) for the error and diagnostic information for the AIM gauge.

**Table 27 - Error/diagnostic monitoring AIM**

Diagnostic messages	Description
Over Range	(Gauge output >11.000 V) Indicates that the measured gas pressure is outside the range of the gauge or the wrong gas type has been selected. Check the gas selected is correct, switch off the gauge, clear the error, reduce the process pressure to within the range of the gauge and press 'Cycle'. If the error persists, there is a fault with the gauge and the electronics module should be replaced.
Under Range	(Gauge output <0.025 V) Indicates that there is a fault with the gauge or cable. Replace the cable and if the fault persists, the electronics module should be replaced.
Striking	Indicates that the gauge is attempting to strike. TIC will continue in this mode for up to 15 minutes.
Not Struck	Indicates that the gauge failed to strike within 15 minutes. This is most likely to be because of the gauge tube becoming contaminated. The gauge tube should be inspected for signs of contamination or debris. If the anode and cathode are not bright, the gauge should be cleaned or the electrodes replaced (D14545802 or D14661802) as described in the AIM instruction manual.

### 4.10.6 Active Ion Gauge (AIGX-S) control

**Note:** TIC does not support the AIGX-D variant of the AIGX range.

**Note:** For a detailed specification and instructions regarding the use of the AIGX, refer to the instruction manual (D04850880).

The Active Ion Gauge (AIGX-S) is a fully integrated active instrument, with a measuring range of  $6.6 \times 10^{-2}$  to  $6.6 \times 10^{-10}$  mbar ( $5 \times 10^{-2}$  to  $5 \times 10^{-10}$  Torr). The gauge has a 1 volt/decade linear output in the range 0 to 10 V d.c. The AIGX-S is supplied with two filaments, which may be manually selected at the gauge head. For maximum filament life, the gauge includes automatic emission current switching and high-pressure shutdown. The only user selectable features are a setpoint and degas facility.

The gauge also includes a comprehensive range of diagnostic outputs, which are displayed on TIC. AIGX has menu options in addition to those shown. (Refer to Default setup options (all gauges) Section 4.10.1. (Refer to Table 28 and Figure 25).

Table 28 - Setup options AIGX

Menu option	Description
Degas	<p>Allows the user to degas the gauge.                      'Scroll' to 'Degas' and press 'Select'.                      'Command Sent' appears for 1 s to confirm degas sequence initiated.</p> <p><b>Note:</b> Whilst the gauge is degassing, the pressure output may read slightly higher than normal.</p> <p>The maximum duration of the degas cycle is 3 minutes, during which the pressure shown on the 'View' screen will be suffixed with a 'D'.                      At the end of the cycle, the gauge will automatically return to its normal operating mode.</p> <p>If the pressure rises above <math>1.3 \times 10^{-4}</math> mbar (<math>1 \times 10^{-4}</math> Torr) during the cycle, degas will automatically stop until the pressure falls below <math>4 \times 10^{-5}</math> mbar (<math>3 \times 10^{-5}</math> Torr), at which point degas resumes for the remainder of the cycle.</p> <p><b>Note:</b> There is no facility enabling degas to be manually switched off mid-cycle.</p>

Figure 25 - Gauge setup screen AIGX

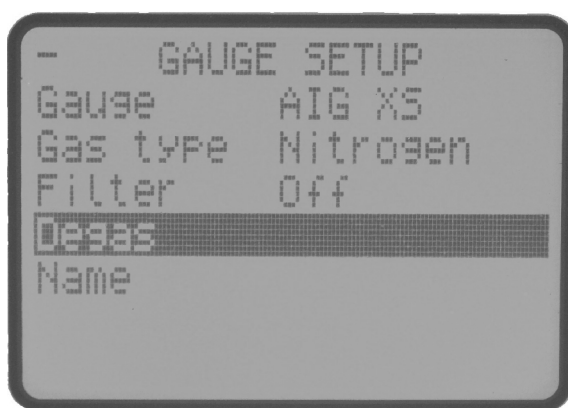

gea/TIC/f24

AIGX has a built-in error monitoring capability. (Refer to Table 29).

**Table 29 - Error/diagnostic monitoring AIGX**

Diagnostic messages	Description
Over Range	(Gauge output >9.800 V) Indicates that there is a fault with the gauge and the electronics module should be replaced.
Over Pressure	(Gauge output = 9.700 V) Indicates that the gauge has automatically shut down, because of pressure rising above $6.6 \times 10^{-2}$ mbar ( $5 \times 10^{-2}$ Torr). Reduce pressure and re-enable the gauge.
Emission Error	(Gauge output = 9.500 V) Indicates that either the filament is broken (switch over) or gauge was enabled at too high a pressure - reduce and re-enable. Electrical supply is out of spec - check the cables (length and cross section).
Under Range	(Gauge output <0.025 V) Indicates that either the gauge internal fuse has blown or there is a fault with the gauge. The fuse should be replaced as described in the AIGX instruction manual and if the fault persists, the electronics module should be replaced.
Initialising	Indicates that the gauge is establishing an emission current. This usually takes about 5 seconds.

#### 4.10.7 Wide Range Gauge (WRG)

**Note:** For a detailed specification and instructions regarding the use of the WRG, refer to the instruction manual (D14701885).

The WRG is a combined Pirani and inverted magnetron gauge in a single compact unit. The WRG measures pressure from atmosphere down to  $1 \times 10^{-9}$  mbar ( $7.5 \times 10^{-10}$  Torr). The WRG is gas dependent and has a log/linear output in the range 2-10 V d.c. The Pirani part of the gauge measures from atmosphere to  $1 \times 10^{-3}$  mbar ( $7.5 \times 10^{-3}$  Torr) while the inverted magnetron measures from  $1 \times 10^{-2}$  down to  $1 \times 10^{-9}$  mbar ( $7.5 \times 10^{-3}$  to  $7.5 \times 10^{-10}$  Torr). Output from both sensors is used to determine pressure between  $1 \times 10^{-2}$  and  $1 \times 10^{-3}$  mbar ( $7.5 \times 10^{-3}$  and  $7.5 \times 10^{-4}$  Torr).

WRG has menu options in addition to those shown. (Refer to Default setup options (all gauges) Section 4.10.1. (Refer to Table 30 and Figure 26).

**Table 30 - Setup options WRG**

Menu option	Description
Calibrate	Allows the user to perform the atmosphere and vacuum adjustment on the WRG.  Connect the WRG to TIC and allow it to operate at atmospheric pressure for at least 10 minutes.  'Scroll' to 'Calibrate' and press 'Select'.  'Command Sent' appears for 1 s to confirm instruction has been carried out.  The WRG will automatically perform a Pirani sensor vacuum setting every time it is pumped down below $1 \times 10^{-4}$ mbar ( $7.5 \times 10^{-5}$ Torr).

Figure 26 - Gauge setup screen WRG

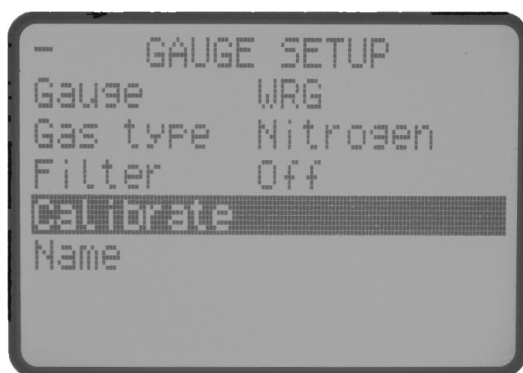

gea/TIC/f25

**Note:** If the Pirani sensor is replaced (see WRG instruction manual D14701885) it may initially fail to indicate pressures less than  $1 \times 10^{-3}$  mbar ( $7.5 \times 10^{-4}$  Torr). In this case a manual vacuum calibration is required. Pump down to  $1 \times 10^{-5}$  mbar ( $7.5 \times 10^{-6}$  Torr) or below before performing the CAL operation as described in the instruction manual.

WRG has a built-in error monitoring capability. (Refer to Table 31).

Table 31 - Error/diagnostic monitoring WRG

Diagnostic messages	Description
Over Range	(Gauge output >10.600 V) Indicates that there is a fault with the gauge and it should be replaced.
Not Struck	(Gauge output = 1.300 V) Indicates that the magnetron part of the gauge has not struck. The gauge tube should be inspected for signs of contamination or debris. If the anode and cathode are not bright, the gauge should be cleaned as described in the WRG instruction manual.
Striker Fail	(Gauge output = 1.200 V) Indicates that the striker filament has broken. The electrode assembly (D14701802) should be replaced as described in the WRG instruction manual.
Mag Fail	(Gauge output = 1.100 V) Indicates that the magnetron part of the WRG has shorted out. This could be because of contamination or a foreign body. The WRG should be cleaned as described in the instruction manual. If this fails to rectify the fault, the WRG should be serviced and the electrode assembly (D14701802) replaced as described in the instruction manual.
Filament Fail	(Gauge output = 1.000 V) Indicates that the Pirani element of the gauge has failed. The most likely fault being a broken filament. The WRG should be serviced as described in the instruction manual.
Under Range	(Gauge output <0.950 V) Indicates that there is a fault with the gauge and the electronics module should be replaced.

#### 4.10.8 Wide Range Hot Cathode Gauge (WRH)

**Note:** For detailed specification and instructions regarding the use of the WRH gauge, refer to the instruction manual (D147508xx).

**Note:** An adaptor (D14750300) is required to connect the TIC

The Wide Range Hot Cathode Gauge is a combination of a Hot Cathode (Bayard-Alpert) and an Active Pirani filament. It is a fully integrated active instrument, with a measurement range from atmosphere to  $5 \times 10^{-10}$  mbar. The measurement is gas dependent, (refer to default setup options (all gauges) [Section 4.10.1](#)) for instruction on setting the gas type.

The gauge supports a Degas function which can be initiated via the Gauge Setup menu. Degas should only be done at pressures below  $2.0 \times 10^{-6}$  mbar.

**Table 32 - Setup options WRH**

Menu option	Description
Degas	<p>Allows the user to degas the gauge. 'Scroll' to 'Degas' and press 'Select'. 'Command Sent' appears for 1 second to confirm degas sequence has initiated.</p> <p><i>Note:</i> While the gauge is degassing, the pressure output may read slightly higher than normal. The reading on the display is suffixed with a 'D' to indicate degassing is in progress.</p> <p>The degas procedure stops automatically after approximately 3 minutes and will cancel if the pressure increase above the degas threshold.</p>

The WRH has built-in error monitoring capability, (Refer to [Table 33](#)).

**Table 33 - Error monitoring**

Diagnostic messages	Description
Under range	Pressure output voltage of 0.5 V to 1 V - increase the pressure to gain reading
Fault	Pressure output voltage <0.5 V - repair or replace sensor

## 4.11 Alarms

If an Alarm occurs, an 'Alarms' warning will begin flashing in the lower half of the view screen. Refer to [Figure 18](#).

The Alarm can then be selected by moving the cursor over it and pressing the 'Select' (↵) button. This action will lead to the Alarms screen. Alternatively, the Alarms screen can be accessed through the main menu.

The Alarm will stop flashing when it has been acknowledged and will disappear when the alarm situation no longer exists. An alarm is acknowledged by pressing the 'Select' (↵) button whilst the flashing alarm is highlighted.

To clear an alarm, to refer to the fault finding guide in [Section 5](#) of this instruction manual. This guide gives information of what the alarm is and the possible solutions for clearing the alarm.

In a similar way a warning can appear. To clear it, take the same actions as for alarms above.

## 4.12 The main menu

The main menu can be accessed by pressing the 'Menu' (☰) button on the view screen (refer to [Figure 15](#)). From here the following sub-menus can be accessed.

## 4.13 Turbo status

This screen allows the user to view the current status of the Turbo and Backing pumps. Basic information such as:

- Whether the Turbo pump is ON or OFF and a graph of its speed.
- The state of the turbo pump that the user has requested.

- Whether the Backing pump is ON or OFF.
- The power that the Turbo pump is using.
- The speed of the Turbo pump as a percentage of full speed.
- The temperature of the Turbo drive. (Only on DX and nEXT pumps).
- The temperature of the Turbo pump/motor. (Only on DX and nEXT pumps).
- The temperature of the Turbo rotor. (Only on nEXT85 family pumps).
- The cycle time is the run time of the current cycle. (Only on DX and nEXT pumps).
- Whether the TIC vent valve is 'on/off'.
- Service menu - enter, press enter to move to the nEXT Service screen.

Table 34 - nEXT Service Screen

nEXT Service	Description
Service due	Indicates which service is due - None, Oil, Bearing, Turbo, Controller. Shows only initial letters if multiple services are due - O B T C.
Oil run	Hours run since last service.
Oil until	Hours left to run until next service.
Bearing run	Hours run since last service.
Bear until	Hours left to run until next service.
Turbo run	Hours run since last service.
Turbo until	Hours left to run until next service.
Contlr run	Stress adjusted hours controller has been powered since last service. Stress adjustment - hours can advance slower or faster than real time depending on temperature and load.
Cntlr until	Stress adjusted hours controller is powered left until next service.
Turbo cycle	Start/stop cycles run since last service.
Cycle until	Start/stop cycles left to run until next service.
Knock count	Backup bearing contacts since last service.
Reset Service Due...	Press enter to move to the nEXT Service Reset screen.

Table 35 - nEXT Service Reset Screen

nEXT Service Reset	Description
Select line below and press enter after servicing	Instructions to follow
Reset oil due	Press enter key to reset only the oil service due
Reset bearing due	Press enter key to reset only the bearing service due

## 4.14 Backing status

This screen allows the user to view the current status of the Turbo and Backing pumps. Basic information such as:

- Whether the Backing pump is ON or OFF and a graph of its speed.
- The state of the turbo pump that the user has requested.
- Whether the Backing pump is ON or OFF.

- The power that the Backing pump is using.
- The speed of the Backing pump as a percentage of full speed.
- The temperature of the Backing drive. (Only on nXDS pumps).
- The cycle time is the run time of the current cycle. (Only on nXDS pumps).
- Whether the TIC vent valve is 'on/off'.
- Service menu - enter, press enter to move to the nXDS Service screen.

**Table 36 - nXDS Service Screen**

nXDS Service	Description
Service due	Indicates which service is due - None, Tip Seal, Bearing, Backing, Controller. Shows only initial letters if multiple services are due - O B T C.
TipSeal run	Hours run since last service.
TipSeal til	Hours left to run until next service.
Bearing run	Hours run since last service.
Bear until	Hours left to run until next service.
Back run	Hours run since last service.
Cntrl run	Stress adjusted hours controller has been powered since last service. Stress adjustment - hours can advance slower or faster than real time depending on temperature and load.
Back cycle	Start/stop cycles run since last service.
Reset Service Due	... Press enter to move to the nXDS Service Reset screen.

**Table 37 - nXDS Service Reset Screen**

nXDS Service Reset	Description
Select line below and press enter after servicing	Instructions to follow
Reset Tip Seal due	Press enter key to reset only the oil service due
Reset bearing due	Press enter key to reset only the bearing service due

## 4.15 Linking gauges and pumps

When the Link Gauges and Pumps option is selected from the main menu, a list of controllable items (gauges and/or pumps) is displayed, along with the item that is currently controlling each of them. By default, each item is 'Not Linked' indicating that nothing is in control of the item.

There are four steps to set up the link, as follows:

1. Select the controlled item. Scroll to the item that is to be controlled and press the 'Select' (↵) button as shown in [Figure 27](#).

Figure 27 - Controlled item

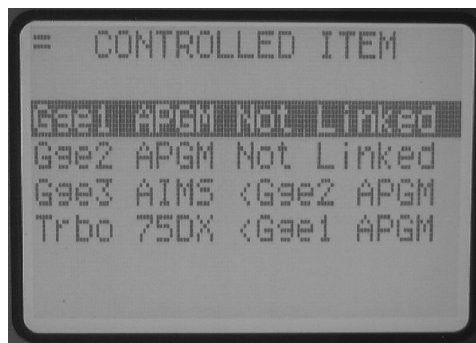

dcs/0117/012

- Select the controlling item. The top highlighted line is used to select the controlling item. Select the controlling item from the list of those available and press the 'Select' (↵) button to confirm the choice. As the item type is changed, the units will change to either 'Pressure' for a gauge or 'Speed' for a pump.
- Enter the required setpoints. The on and off setpoints can be adjusted to suit the application. If the controlling item is a pump, the unit used for the setpoint is speed (%). If the controlling item is a gauge, the units can be changed between pressure (current pressure units) and voltage (V). Select the units to be used and then adjust the on and off setpoints as required as shown in Figure 28.

Figure 28 - Control setup

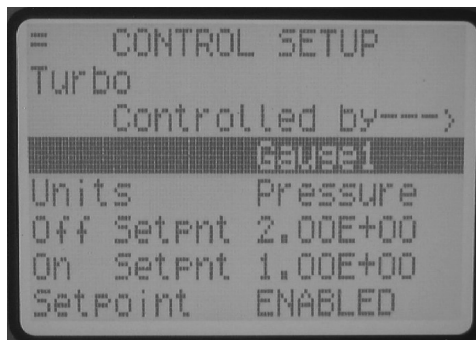

dcs/0117/013

- Note:** For gauges controlled by another gauge: Off setpoint  $\geq$  On setpoint.  
 For gauges controlled by a Turbo pump: Off setpoint  $\leq$  On setpoint.  
 For pumps controlled by a gauge: Off setpoint  $\geq$  On setpoint.  
 If the adjustment of either the On or Off setpoint results in the above rules being broken, the setpoint that was not adjusted will be altered to match the newly entered one.
- Note:** When entering a pressure, the sign of the exponent can only be changed when the exponent is non-zero. To set a negative exponent, the exponent value should be set first, and then the 'Menu' (☰) button used to move back to alter the sign.

- Enable the setpoint. Once configured, the setpoint should be enabled by changing the bottom 'Setpoint' line from 'OFF' to 'ENABLED'.

## 4.16 Parameters/units

This screen allows the user to change the units that are displayed and other parameters such as:

- Setup lock - When the 3 digit lock code is entered, the lock is enabled and an operator will not be able to change any of the setups, however the operator is still able to scroll through the menus and start and stop pumps. The lock is disabled by entering the 3 digit unlock code. Lock - 501, unlock - 147.



- Panel Lock - This function completely locks the front panel. An operator will only be able to see the view screen. Lock - 509, unlock - 824.
- The 0 - 10 V analogue output on the logic interface can be set to follow either gauge 1, 2 or 3, pressure, or turbo speed.
- Display contrast allows the user to change the contrast of the display.
- Protocol shows whether RS232 or RS485 is being used.
- Comms address - To set the comms address of the TIC.
- TMPI Alert off - To disable/enable the warning when using TMPI line to start the Turbo pump.
- BMPI Alert off - To disable/enable the warning when using BMPI line to start the Backing pump.

## 4.17 Screen options

The user can utilise this screen to choose what is to be displayed on the view screen. The options include:

- Show all items - This is the default setting of the view screen.
- Show three gauges.
- Set three gauge order.
- One gauge at a time - This allows the user to view just a single gauge 3 x height.
- Show one gauge.
- Set one gauge order.
- Pumps only - This screen allows the user to view only the Turbo information.
- Show one gauge and pumps - This screen allows the user to view turbo plus one gauge information.

### 4.17.1 Organising gauges on the view screen

The three gauge order and one gauge order functions are used to set up what gauges and in what order the gauges are shown on the view screen. In the following example the user wants to set the order below:

- Position 1: The gauge plugged into the 'gauge 1' connection.
- Position 2: A gauge is not plugged into the 'gauge 2' connection, the user does not want Position 2 to be shown on the screen. The No gauge selection has been made.
- Position 3: The gauge plugged into the 'gauge 2' connection.

Figure 29 - Gauge order setup

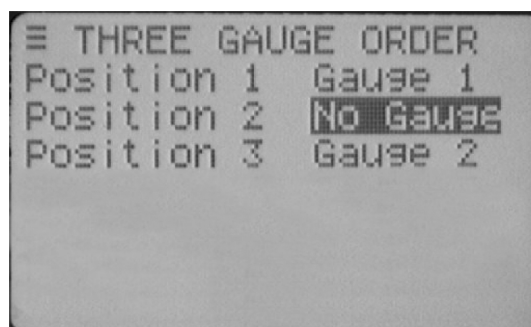

gea/d39701/f26

**Note:** The user can set up different ordering, to show three gauges or one gauge.

Once the setup is complete and the user views the screen, the gauge set up at position one is shown first. The user can scroll around to the other gauges set up in the positions defined. In the example above, only 2 positions can be scrolled to as the user has chosen that position 2 will not be shown when returning to the main view screen.

## 4.18 Relay setpoint outputs

The relay setpoints option allows the setpoint outputs on the logic interface to be linked to a gauge pressure or pump speed. They are set up in the same way as Linking Gauges and Pumps, refer to [Section 4.15](#).

When a relay setpoint becomes active, the display section on the view screen will change to reverse video.

## 4.19 Service information

Service information contains the following information:

- Software Issue - This is the issue of the currently installed software. This will change when new software is downloaded to the TIC in the future.
- Serial Number - The serial number of the TIC is used when contacting Edwards about the product.
- Analogue O/P - The analogue output value (internal units) is used when contacting Edwards about the product.
- PSU Temp - Temperature of PSU.
- TIC Temp - Temperature of TIC.
- Turbo run - Number of hours the turbo pump has been run (DX and nEXT pumps only).
- Upload Turbo - The TIC can store one set of the pump's configuration. This function will upload the current configuration from the attached pump (DX and nEXT pump only).
- Download Turbo - The TIC can download one set of configurations to DX/nEXT pumps, once a configuration has been uploaded. This function will download the stored configuration to the attached pump (DX and nEXT pump only).
- Reset Trbo - Reset the turbo pump to its factory defaults (DX and nEXT pumps only).
- Reset TIC - Resets the TIC to its factory default configuration and can be used to quickly undo all user settings (links between gauges and pumps, relay setpoints, units, gauge gas types, etc.).

## 4.20 Electrical supply failure

If the electrical supply to the controller fails while the turbo pump is rotating at high speed, the pump begins acting like a generator, maintaining operation of the pump electronics and supporting operation of any accessories connected directly to the pump such as a vent valve or fan.

Additionally, certain turbo pumps can make power available to a TIC to maintain the operation of vent valves connected to the TIC.

Where power is returned to the TIC it is not made available to the gauges, the logic interface or the air cooler. All of these will stop operating until power is restored.

Once the turbo pump speed falls below 50%, the vent valve will open and the TIC will shut down.

Refer to the individual pump instruction manuals for availability of this feature.

Turbo Pump	Power to TIC
EXT75DX	Supported

Turbo Pump	Power to TIC
nEXT240/300/400/730/930/1230 family	Not supported
nEXT85 family	Supported if option enabled

This page has been intentionally left blank.

## 5 Maintenance

### 5.1 Safety



#### WARNING

Obey the safety instructions in this Section and take note of appropriate precautions. Failure to observe these instructions may result in injury to people and damage to equipment.

There are no serviceable parts on the TIC. Do not open. Return to the nearest Edwards service centre for repairs.

The Edwards return of equipment forms can be found at the rear of this manual.

### 5.2 Fault finding

Table 38 - Fault finding

	Diagnostic messages	Description
Pump	RampUp Timeout	Refer to Table 11.
	Droop Timeout	Refer to Table 11.
DX and nEXT	Serial ID Fail	Refer to Table 16.
	Turbo Fault	Refer to Table 16.
	SC Interlock	Refer to Table 16.
	Uload Timeout	Refer to Table 16.
	Dload Failed	Refer to Table 16.
	nEXT Service Due	Refer to Table 16.
Gauge	Over Range	Refer to appropriate Section in manual.
	Under Range	Refer to appropriate Section in manual.
	New ID	Refer to Table 20.
	Uknw	Refer to Table 20.
	Not connected	Refer to Table 20.
	Not Struck	Refer to appropriate Section in manual.
	Filament Fail	Refer to appropriate Section in manual.
	Mag Fail	Refer to Table 31.
	Striker Fail	Refer to Table 31.
	Cal Error	Refer to Table 24.
	Initialising	Refer to Table 29.
	Emission Error	Refer to Table 29.
	Over Pressure	Refer to Table 29.
ASG2 Cant Zero	Refer to Table 26.	

Table 38 - Fault finding (continued)

	Diagnostic messages	Description
General	SYSI Inhibit	The system interlock has been disconnected. Please check that the logic interface plug is connected correctly, or check the status of the system interlocks.
	Ext Inhibit	Enable lines have been disconnected, please check the Turbo or Backing pump enable lines.
	No Reading	An object has not received a value update from its source within a given time and is flagging that its value is now old. Check connections to components of system.
	No Message	An object has not received a reply to a message it sent within a given time. Check logic interface connections, are correctly attached to the TIC.
	Brownout/Short	Either the loading on the TIC outputs exceeds a certain current level or there was a brownout of the mains power while a turbo was spinning and could provide some regen power. Remove the short or high load and then accept the error; the TIC will re-attempt to drive the output. If a brownout occurs, wait for it to pass and then accept the error.

### 5.3 Cleaning the controller

If necessary, use a soft dry cloth to clean the exterior of the controller. Do not clean with harsh abrasives or liquids.

If the interior of the controller requires cleaning, Edwards recommends returning the controller to the supplier or the nearest Edwards Service Centre.

### 5.4 Software updates

The software within the controller and the TIC PC monitor program will be updated as part of Edwards ongoing development program. The updates and associated instruction manual can be found by visiting [www.upgrades.edwardsvacuum.com](http://www.upgrades.edwardsvacuum.com).

## 5.5 Factory defaults

The following is a list of factory default settings for the TIC:

**Table 39 - Factory default settings**

Menu option	Default
Pump, gauge and relay slaving	- not slaved
Turbo pump start delay	= 0
EXDC Ramp time	= 8
EXDC Droop time	= 8
Gas type	= Nitrogen
Gauge Filter	= Off
Name	= _ _ _ _ (4 spaces)
ASG2 range	= 1000
Analogue out slaved	= NONE
TIC vent	= 50%
Heater band	= 0 hrs
Air Cooler	= Turbo
Setup lock	= Off
Panel lock	= Off
Display contrast	= 5
Pressure units	= mbar
PC comms	= RS232
Multi-drop address	= 0
Default screen	= All
ASG2 fixed/float	= Float
System On	= Backing
System Off	= Turbo
Backing Option	= None

This page has been intentionally left blank.



## 6 Storage and disposal

### 6.1 Storage

Store the controller in clean dry conditions in accordance with the technical specifications. Refer to [Section 2](#) of the main manual on CD.

### 6.2 Disposal

Dispose of the controller and any components safely in accordance with all local and national safety and environmental requirements.

Alternatively, the controller and/or cables may be able to be recycled. Contact Edwards or the supplier for advice.

The controller and associated cables are within the scope of the European Directive on Waste Electrical and Electronic Equipment, 2002/96/EC. Edwards offer European customers a recycling service for the controller/cables at the end of the product's life. Contact Edwards for advice on how to return the controller/cables for recycling.



#### **WARNING**

Do not incinerate the controller. If the controller is heated to very high temperatures, dangerous gases may be emitted and internal components may explode.

This page has been intentionally left blank.

## 7 Service, spares and accessories

### 7.1 Introduction

Edwards products, spares and accessories are available from Edwards companies in Belgium, Brazil, China, France, Germany, Israel, Italy, Japan, Korea, Singapore, United Kingdom, U.S.A and a world-wide network of distributors. The majority of these centres employ Service Engineers who have undergone comprehensive Edwards training courses.

When maintaining this product, Edwards recommends using only Edwards maintenance and service kits.

Order spare parts and accessories from the nearest Edwards company or distributor. When ordering, please state for each part required:

- Model and Item Number of the equipment
- Serial number
- Item Number and description of the part

### 7.2 Service

Edwards products are supported by a world-wide network of Edwards Service Centres. Each Service Centre offers a wide range of options including: equipment decontamination; service exchange; repair; rebuild and testing to factory specifications. Equipment which has been serviced, repaired or rebuilt is returned with a full warranty. Local Service Centres can also provide Edwards engineers to support on-site maintenance, service or repair of the equipment.

For more information about service options, contact the nearest Service Centre or other Edwards company.

#### 7.2.1 Return the equipment or components for service

Before you send your equipment to us for service or for any other reason, you must send us a completed Declaration of Contamination of Vacuum Equipment and Components - Form HS2. The HS2 form tells us if any substances found in the equipment are hazardous, which is important for the safety of our employees and all other people involved in the service of your equipment. The hazard information also lets us select the correct procedures to service your equipment.

We provide instructions for completing the form in the Declaration of Contamination of Vacuum equipment and Components - Procedure HS1.

Download the latest documents from [www.edwardsvacuum.com/HSForms/](http://www.edwardsvacuum.com/HSForms/), follow the procedure in HS1, fill in the electronic HS2 form, print it, sign it, and return the signed copy to Edwards.

**Note:** *If we do not receive a completed HS2 form, your equipment cannot be serviced.*

## 7.3 Spares

Table 40 - Spares

Spares	Item Number
TIC front Bezel Kit	D39700803
Front panel assembly	D39700822

*Note: This assembly is suitable for customers who have electrical and electronic repair expertise and possess a portable appliance tester. If the customer is unable to carry out this repair, the controller should be returned to Edwards for a full repair and safety re-test.*

## 7.4 Accessories

Table 41 shows the range of accessories that can be purchased.

Table 41 - Accessories

Product Description	Ordering Information
TIC Profibus Module	D39750000
APG200 series	
ASG2	
AIM-S, AIM-SL, AIM-X, AIM-XL ranges	
WRG-S and WRG-SL	
<b>Active Gauge Cables (including FCC68 compatible connections at both ends)</b>	
0.5 m active gauge cable	D40001005
1 m active gauge cable	D40001010
3 m active gauge cable	D40001030
5 m active gauge cable	D40001050
10 m active gauge cable	D40001100
15 m active gauge cable	D40001150
15 m active gauge cable (24 AWG)	D40005150
25 m active gauge cable	D40001250
30 m active gauge cable (24 AWG)	D40005300
50 m active gauge cable	D40001500
100 m active gauge cable	D40001999
nEXT range	
<b>Extension Cables DX/EXDC and 24 V backing pumps</b>	
1 m DX/EXDC extension cable (16/0.2)	D39700835
3 m DX/EXDC extension cable (16/0.2)	D39700836
5 m DX/EXDC extension cable (16/0.2)	D39700837
<b>Air Cooler</b>	
ACX70	B58053050
ACX250	B58053150

Table 41 - Accessories (continued)

Product Description	Ordering Information
<b>Vent Valves</b>	
TAV5	B58066010
TAV6	B58066020
<b>Examples of compatible 24 V backing pumps</b>	
XDD1 24 V d.c. Diaphragm pump	A74601991
<b>Examples of compatible mains backing pumps</b>	
XDS10 220-240 V 50 Hz 1-phase	A72601903
XDS10 115-120 V 60 Hz 1-phase	A72601906
nXDS6i 100-127/200-240 V 50/60 Hz 1-phase	A73501983
nXDS10i 100-127/200-240 V 50/60 Hz 1-phase	A73601983
nXDS15i 100-127/200-240 V 50/60 Hz 1-phase	A73701983
nXDS20i 100-127/200-240 V 50/60 Hz 1-phase	A73801983
E2M1.5 220-240 V 50/60 Hz 1-phase	A37122919
E2M1.5 115-120 V 50/60 Hz 1-phase	A37122902
RV12 110-120 V 60 Hz or 220-240 V 50 Hz 1-phase	A65501903
E2M28 220-240 V 50 Hz or 230-240 V 60 Hz 1-phase	A37315903
E2M28 115/230 V 60 Hz 1-phase	A37315981
<b>Bakeout band (via optional relay box)</b>	
BX70 240 V 30 W (EXT70H & EXT75DX)	B58052060
BX70 110 V 30 W (EXT70H & EXT75DX)	B58052040
BX250 240 V 60 W (EXT255H)	B58052061
BX250 110 V 60 W (EXT255H)	B58052041
<b>24V backing line valves (via optional relay box)</b>	
LCPV16EKA 24 V a.c./d.c.	C41751200
LCPV25EKA 24 V a.c./d.c.	C41752200
<b>Relay Boxes</b>	
TIC Relay box comb	D39721806
<b>Interface cables</b>	
2 m Logic interface cable	D39700833
2 m RS232 interface cable	D39700834
<b>Mains cables (Suitable for TIC controllers)</b>	
2 m UK plug	D40013025
2 m USA plug	D40013120
2 m Northern European plug	D40013120
<b>Other accessories and supporting products</b>	
TIC updates, software and manuals	<a href="http://www.upgrades.edwardsvacuum.com">www.upgrades.edwardsvacuum.com</a>

This page has been intentionally left blank.

## EU Declaration of Conformity

This declaration of conformity is issued under the sole responsibility of the manufacturer:

**Edwards Ltd**

Innovation Drive  
Burgess Hill  
West Sussex  
RH15 9TW  
UK

**Documentation Officer**

Jana Sigmunda 300  
Lutín , 78349  
Czech Republic  
T: +42(0) 580 582 728  
[documentation@edwardsvacuum.com](mailto:documentation@edwardsvacuum.com)

The product specified and listed below

Product Description: TIC Instrument Controller 6-Gauge

TIC Instrument Controller	D39700000
TIC Instrument Controller 6 Gauge	D39701000
TIC Instrument Controller 6 Gauge Capacitance Manometer	D39702000
TIC Turbo Controller 100W	D39711000
TIC Turbo Controller 200W	D39712000
TIC Turbo & Instrument Controller 100W	D39721000
TIC Turbo & Instrument Controller 200W	D39722000

Is in conformity with the relevant Union harmonisation legislation:

2014/35/EU	Low voltage directive (LVD)
2014/30/EU	Electromagnetic compatibility (EMC) directive Class B Emissions, Industrial Immunity
2011/65/EU	Restriction of certain hazardous substances (RoHS) directive as amended by Delegated Directive (EU) 2015/863

Based on the relevant requirements of harmonised standards and technical documentation:

EN 61010-1:2010+A1:2019	Safety requirements for electrical equipment for measurement, control and laboratory use. General requirements
EN 61326-1:2013	Electrical equipment for measurement, control and laboratory use. EMC requirements. General requirements

This declaration, based on the requirements of the listed Directives and EN ISO/IEC 17050-1, covers all product serial numbers from this date on: *2023-06-01*

You must retain the signed legal declaration for future reference

This declaration becomes invalid if modifications are made to the product without prior agreement.



Nick Barratt - Engineering Manager, Eastbourne



Ed Neuss – General Manager, Eastbourne



## Declaration of Conformity

This declaration of conformity is issued under the sole responsibility of the manufacturer.

**Edwards Ltd**

Innovation Drive  
Burgess Hill  
West Sussex  
RH15 9TW  
UK

**Documentation Officer**

[documentation@edwardsvacuum.com](mailto:documentation@edwardsvacuum.com)

The product specified and listed below

Product Description: TIC Instrument Controller 6-Gauge

TIC Instrument Controller	D39700000
TIC Instrument Controller 6 Gauge	D39701000
TIC Instrument Controller 6 Gauge Capacitance Manometer	D39702000
TIC Turbo Controller 100W	D39711000
TIC Turbo Controller 200W	D39712000
TIC Turbo & Instrument Controller 100W	D39721000
TIC Turbo & Instrument Controller 200W	D39722000

The object of the declaration described above is in conformity with relevant statutory requirements:

Electrical Equipment (Safety) Regulations 2016

Electromagnetic Compatibility Regulations 2016

Class B Emissions, Industrial Immunity

Restriction of the Use of Certain Hazardous Substances in Electrical and Electronic Equipment Regulations 2012

Relevant designated standards or technical specifications are as follows:

EN 61010-1:2010+A1:2019 Safety requirements for electrical equipment for measurement, control and laboratory use. General requirements

EN 61326-1:2013 Electrical equipment for measurement, control and laboratory use. EMC requirements. General requirements

This declaration, based on the requirements of the listed Statutory Instruments and EN ISO/IEC 17050-1, covers all product serial numbers from this date on: *2023-06-01*

You must retain the signed legal declaration for future reference

This declaration becomes invalid if modifications are made to the product without prior agreement.

**Signed for and on behalf of Edwards Ltd**



Nick Barratt - Engineering Manager, Eastbourne



Ed Neuss – General Manager, Eastbourne



## ADDITIONAL LEGISLATION AND COMPLIANCE INFORMATION

EMC (EU, UK): Class B Industrial equipment

Caution: This equipment is not intended for use in residential environments and may not provide adequate protection to radio reception in such environments.

RoHS (EU, UK): Material Exemption Information

This product is compliant with the following Exemptions

Annex III:

- 6(c) Copper alloy containing up to 4% **lead** by weight
- 7(a) **Lead** in high melting temperature type solders (i.e. **lead**-based alloys containing 85 % by weight or more **lead**)
- 7(c) I Electrical and electronic components containing **lead** in a glass or ceramic other than dielectric ceramic in capacitors, e.g. piezoelectronic devices, or in a glass or ceramic matrix compound

REACH (EU, UK)

This product is a complex article which is not designed for intentional substance release. To the best of our knowledge the materials used comply with the requirements of REACH. The product manual provides information and instruction to ensure the safe storage, use, maintenance and disposal of the product including any substance based requirements.

Article 33.1 Declaration (EU, UK)

This product contains Candidate List Substances of Very High Concern above 0.1%ww by article as clarified under the 2015 European Court of Justice ruling in case C-106/14.

- Lead (Pb)  
This substance is present in certain brass / electrical or electronic components.
- Lead Oxide / Lead monoxide / Lead (II) oxide  
This substance is present in certain electrical or electronic components.
- 6,6'-di-tert-butyl-2,2'-methylenedi-p-cresol (DBMC)  
This substance is present in certain electronic components.

### Additional Applicable Requirements

The product is in scope for and complies with the requirements of the following:

2012/19/EU

Directive on waste electrical and electronic equipment (WEEE)

材料成分声明

China Material Content Declaration

部件名称 Part name 	有害物质 Hazardous Substances					
	铅 Lead (Pb)	汞 Mercury (Hg)	镉 Cadmium (Cd)	六价铬 Hexavalent Chromium (Cr VI)	多溴联苯 Polybrominated biphenyls (PBB)	多溴二苯醚 Polybrominated diphenyl ethers (PBDE)
铜接头 Brass connectors	X	O	O	O	O	O
电缆/电线/连接器 Cable/wire/connector	X	O	O	O	O	O
印刷电路组件 (PCA) Printed Circuit Assembly (PCA)	X	O	O	O	O	O
电子元件和控件 Electronics and Controls	X	O	O	O	O	O
<p>O: 表示该有害物质在该部件的所有均质材料中的含量低于 GB/T 26572 标准规定的限量要求。 O: Indicates that the hazardous substance contained in all of the homogeneous materials for this part is below the limit requirement in GB/T 26572.</p> <p>X: 表示该有害物质在该部件的至少一种均质材料中的含量超出 GB/T26572 标准规定的限量要求。 X: Indicates that the hazardous substance contained in at least one of the homogeneous materials used for this part is above the limit requirement of GB/T26572.</p>						

This page has been intentionally left blank.

